

FOR TYPICAL REMOTE CONTROL DETAILS, SEE DOCUMENT **RWS100**

TRANSFORMER TAPPING OPTIONS	
Tap	Nominal 50/60Hz
TYPE 1	
W	220/230
X	380/400
Y	400,415/420
Z	440/460
FUSE FS 1=250mA ANTI-SURGE	
TYPE 2	
W	346/380
X	480/500
Y	240/240
Z	550/575
FUSE FS 1=250mA ANTI-SURGE	
TYPE 3	
X	660/660-690
Y	690/-
FUSE FS 1=150mA ANTI-SURGE	

REFER TO SHEET 2 FOR NOTES & OPTION PCB'S IF FITTED



FS2 (IF FITTED) 100mA

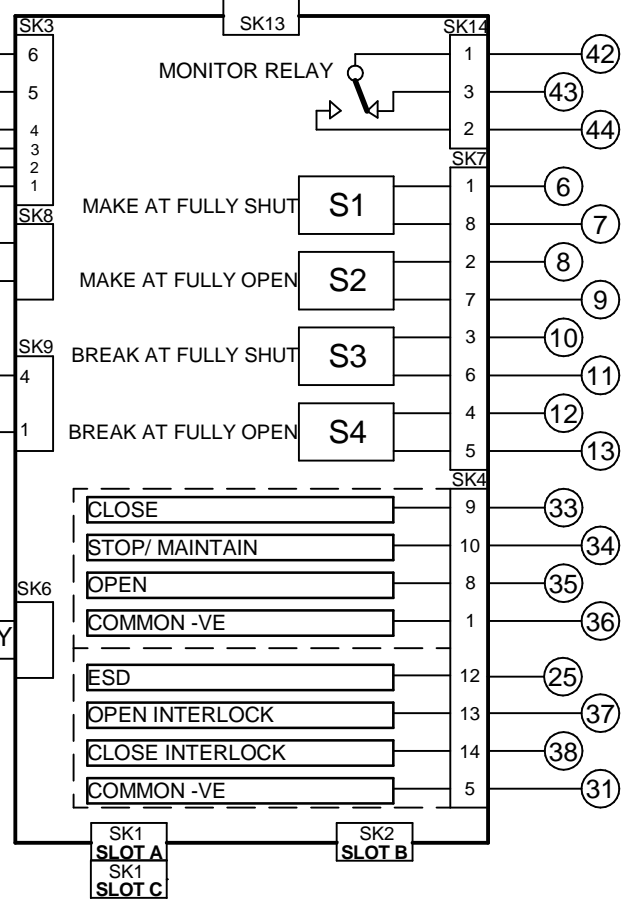
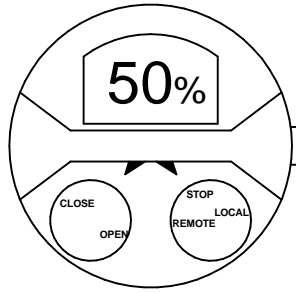

Iss	Date	Chkd	Revision Details
1	190218	JC1	First Issue.
2	240718	PJW	PROFIBUS PUB SHT2 UPDATED WAS PUB008-005
3	041120	PJW	'TERMINATION' removed from SW1 & SW2 on Sht 2.

www.rotork.com

ROTORK CONTROLS LTD
BATH, BA1 3JQ
ENGLAND
Tel:01225-733200

ROTORK CONTROLS INC
ROCHESTER
NY 14624, USA
Tel:585-247-2304

IQ + CPT + CTT+ DUAL CHANNEL PROFIBUS MODULE AND PROFIBUS DISCONNECT

Drawn by: PJW
Date : 190218
Base WD: 102P3004
Job No : --
MI No : --

Circuit Diagram Number
102P3004

Issue No
3

Sheet
1
of 2

B1|C1|B2|C2| | | | | |

CIRCUIT DRAWN WITH POWER SUPPLY OFF
24VDC SUPPLY FROM TERMINALS
4 & 5

THE SETTING TOOL ENABLES THE PROFIBUS ADDRESS TO BE CONFIGURED.

SLOT A

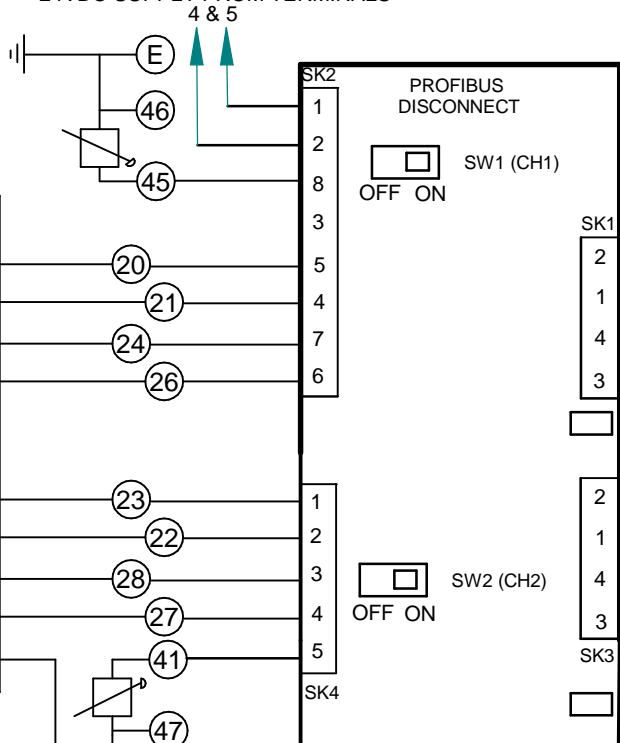
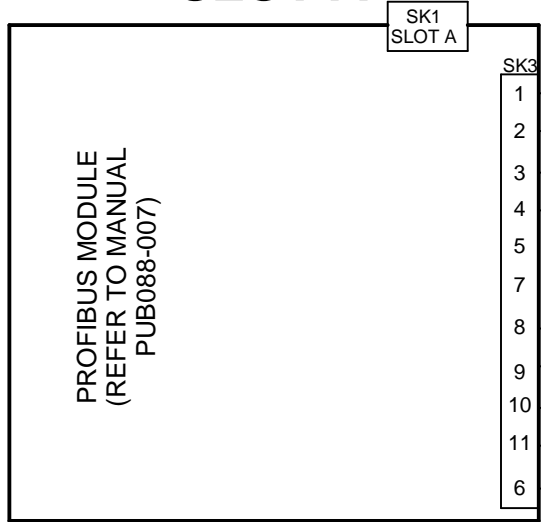

OUTPUT SWITCH SW1 & SW2
OFF - A&B OUT DISCONNECTED
ON - A&B OUT CONNECTED

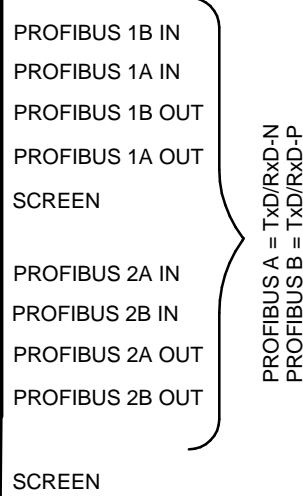

SLOT B

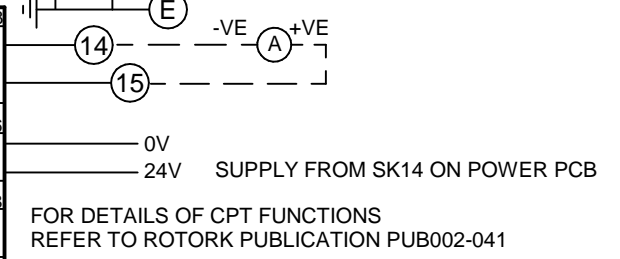
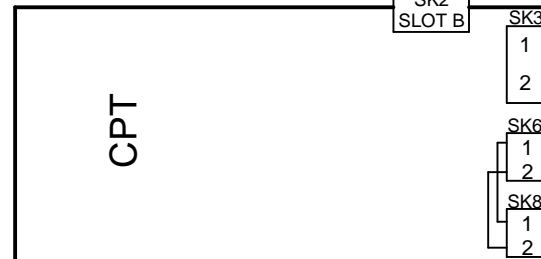

SLOT C

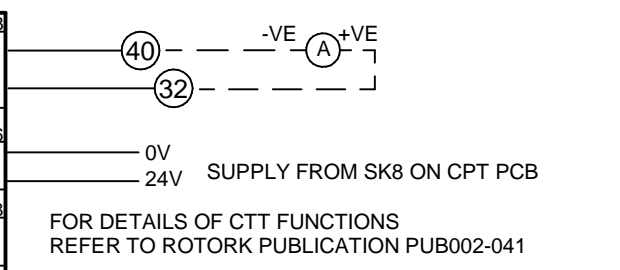
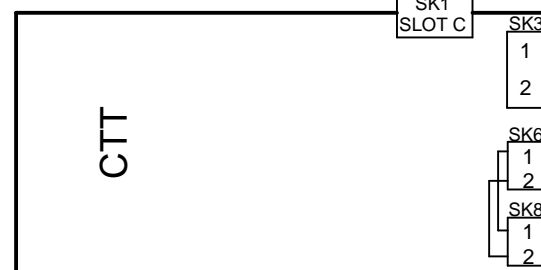

PROFIBUS A = TxD/RxD-N
PROFIBUS B = TxD/RxD-P

NOTES

1.FUSES:

- PS1 is a self-resetting fuse.
- Refer to publication PUB002-039 for approved fuses FS1 and FS2.
- Actuator rated voltage specified on nameplate. Voltage tolerance +/-10%, applies for rated torque performance; duty cycle is not guaranteed.

2.REMOTE CONTROL:

- For typical remote control circuits refer to: -RWS indicated or PUB002-041.
- For DC and AC control, connect -ve/0V to terminal 36.
- (For negative switch / positive common, refer to RWS indicated).
- Control signal threshold voltages:
 - DC: "on" ≥16Vdc / "off" ≤8Vdc, max 60Vdc.
 - AC: "on" ≥60Vac / "off" ≤40Vac, max 120Vac.
- Control signal duration to be 300ms minimum.
- Maximum current drawn from remote control signals is:
 - 8mA at 24Vdc or 12mA at 120Vac.
- Supply provided on terminals 4 & 5:
 - Intended for remote control.
 - Max external load 5W at 24Vdc / 5VA at 120Vac

3.INDICATION:

- For typical position, status and alarm indication see PUB002-041.
- "S" contacts are user configurable and are shown in their default setting.
- Refer to PUB002-040 for functions and configuration instructions.
- Monitor Relay indicates actuator availability for remote control (shown "unavailable"). It can be configured to exclude local/remote selection.
- Refer to PUB002-040 for monitored functions and configuration instructions.
- Voltage applied to indication contacts must not exceed 150Vac
- Individual Switch current must not exceed 3.5A inductive, 5A resistive and no more than 8A in total for all 4 contacts.

4.BATTERY:

- Battery maintains local and remote "S" contact indication only.
- Refer to installation manual for approved replacement battery types.

See Sheet 1 for all Revision details/information

Circuit Diagram Number	Issue No	Sheet
102P3004	3	2 of 2