

FOR TYPICAL REMOTE CONTROL DETAILS, SEE DOCUMENT  
**RWS101**

TRANSFORMER TAPPING OPTIONS	
Tap	Nominal 50/60Hz
TYPE 1	
W	220/230
X	380/400
Y	400,415/420
Z	440/460
FUSE FS 1=250mA ANTI-SURGE	
TYPE 2	
W	346/380
X	480/500
Y	240/240
Z	550/575
FUSE FS 1=250mA ANTI-SURGE	
TYPE 3	
X	660/660-690
Y	690/-
FUSE FS 1=150mA ANTI-SURGE	

REFER TO SHEET 2 FOR NOTES & OPTION PCB'S IF FITTED



FS2 (IF FITTED) 100mA

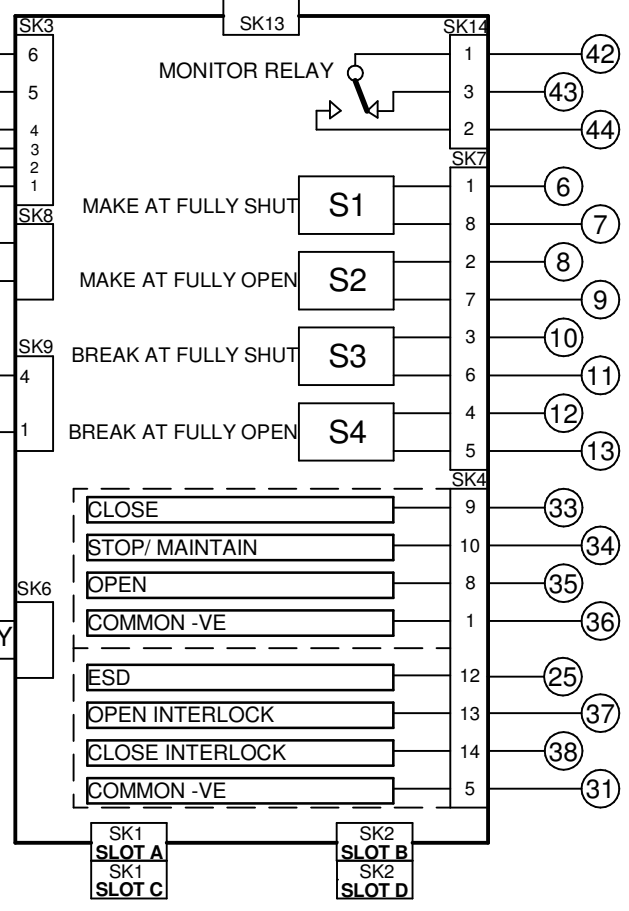
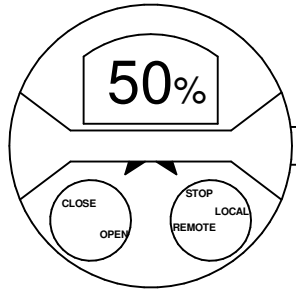

Iss	Date	Chkd	Revision Details
1	070818	JC1	First Issue.

**www.rotork.com**

ROTORK CONTROLS LTD BATH, BA1 3JQ ENGLAND Tel:01225-733200	ROTORK CONTROLS INC ROCHESTER NY 14624, USA Tel:585-247-2304
---	---

IQ + CPT & CTT + EXTRA RELAYS S5-S8 + 120VAC CUSTOMER SUPPLY + RHS

Drawn by: PJW Date : 070818 Base WD: 112B0016 Job No : - - MI No : - -	Circuit Diagram Number <b>112B0016</b>	Issue No <b>1</b> Sheet <b>1</b> of 2
--	---	---

B1|C1|B2|C2|B1|C1|M1|V1

# SLOT A

CIRCUIT DRAWN WITH POWER SUPPLY OFF

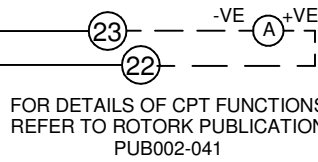
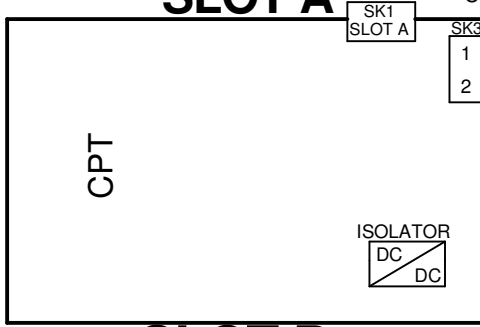

FOR DETAILS OF CPT FUNCTIONS REFER TO ROTORK PUBLICATION PUB002-041

# SLOT B

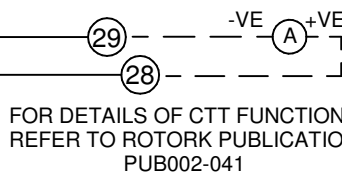
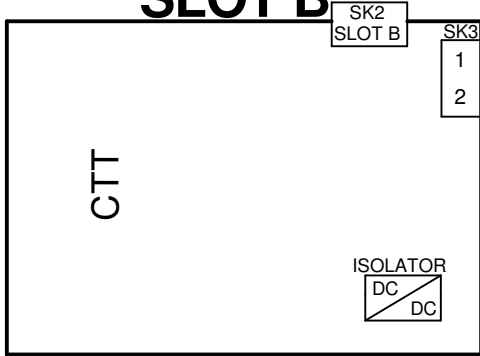

FOR DETAILS OF CTT FUNCTIONS REFER TO ROTORK PUBLICATION PUB002-041

# SLOT C

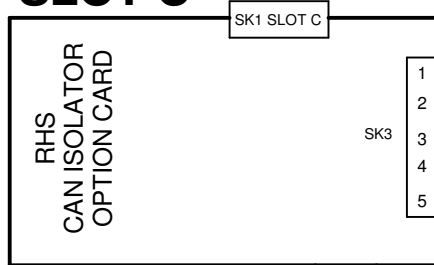

RHS CABLE IS CUSTOMER SUPPLIED, FOR SPECIFICATION SEE PUB002-059, MAXIMUM LENGTH OF CABLE TO BE 100m.

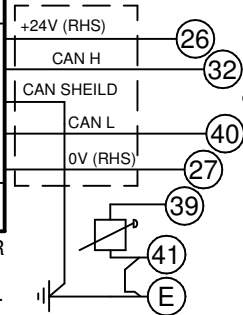

# SLOT D

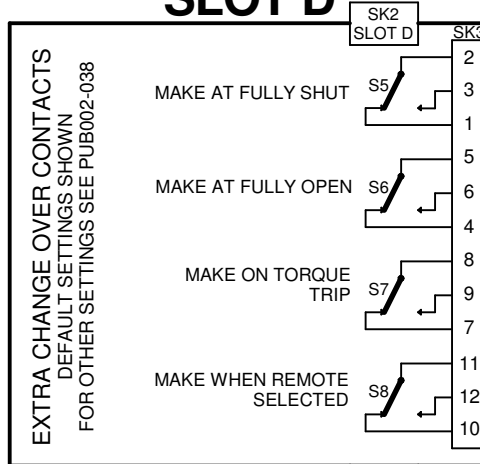

EXTRA CHANGE OVER CONTACTS  
DEFAULT SETTINGS SHOWN  
FOR OTHER SETTINGS SEE PUB002-038

## NOTES

### 1.FUSES:

- PS1 is a self-resetting fuse.
- Refer to publication PUB002-039 for approved fuses FS1 and FS2.
- Actuator rated voltage specified on nameplate. Voltage tolerance +/-10%, applies for rated torque performance; duty cycle is not guaranteed.

### 2.REMOTE CONTROL:

- For typical remote control circuits refer to: -RWS indicated or PUB002-041.
- For DC and AC control, connect -ve/0V to terminal 36.
- (For negative switch / positive common, refer to RWS indicated).
- Control signal threshold voltages:
  - DC: "on" ≥16Vdc / "off" ≤8Vdc, max 60Vdc.
  - AC: "on" ≥60Vac / "off" ≤40Vac, max 120Vac.
- Control signal duration to be 300ms minimum.
- Maximum current drawn from remote control signals is:
  - 8mA at 24Vdc or 12mA at 120Vac.
- Supply provided on terminals 4 & 5:
  - Intended for remote control.
  - Max external load 5W at 24Vdc / 5VA at 120Vac

### 3.INDICATION:

- For typical position, status and alarm indication see PUB002-041.
- “S” contacts are user configurable and are shown in their default setting.
- Refer to PUB002-040 for functions and configuration instructions.
- Monitor Relay indicates actuator availability for remote control (shown “unavailable”). It can be configured to exclude local/remote selection.
- Refer to PUB002-040 for monitored functions and configuration instructions.
- Voltage applied to indication contacts must not exceed 150Vac
- Individual Switch current must not exceed 3.5A inductive, 5A resistive and no more than 8A in total for all 4 contacts.

### 4.BATTERY:

- Battery maintains local and remote “S” contact indication only.
- Refer to installation manual for approved replacement battery types.

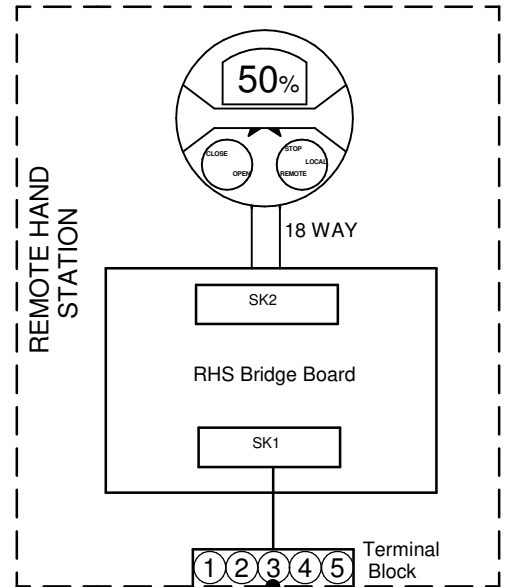

Actuator Terminal Bung No.	RHS Terminal Block No.	Function
26	1	+24V (RHS)
27	2	0V (RHS)
32	3	CAN H
40	4	CAN L
39	5	SHEILD