

PLUG SELECTED VOLTAGE WIRE INTO
TERMINAL "T"
PLACE TWO REMAINING WIRES INTO
POSITIONS "P"
(ORDER NOT IMPORTANT)

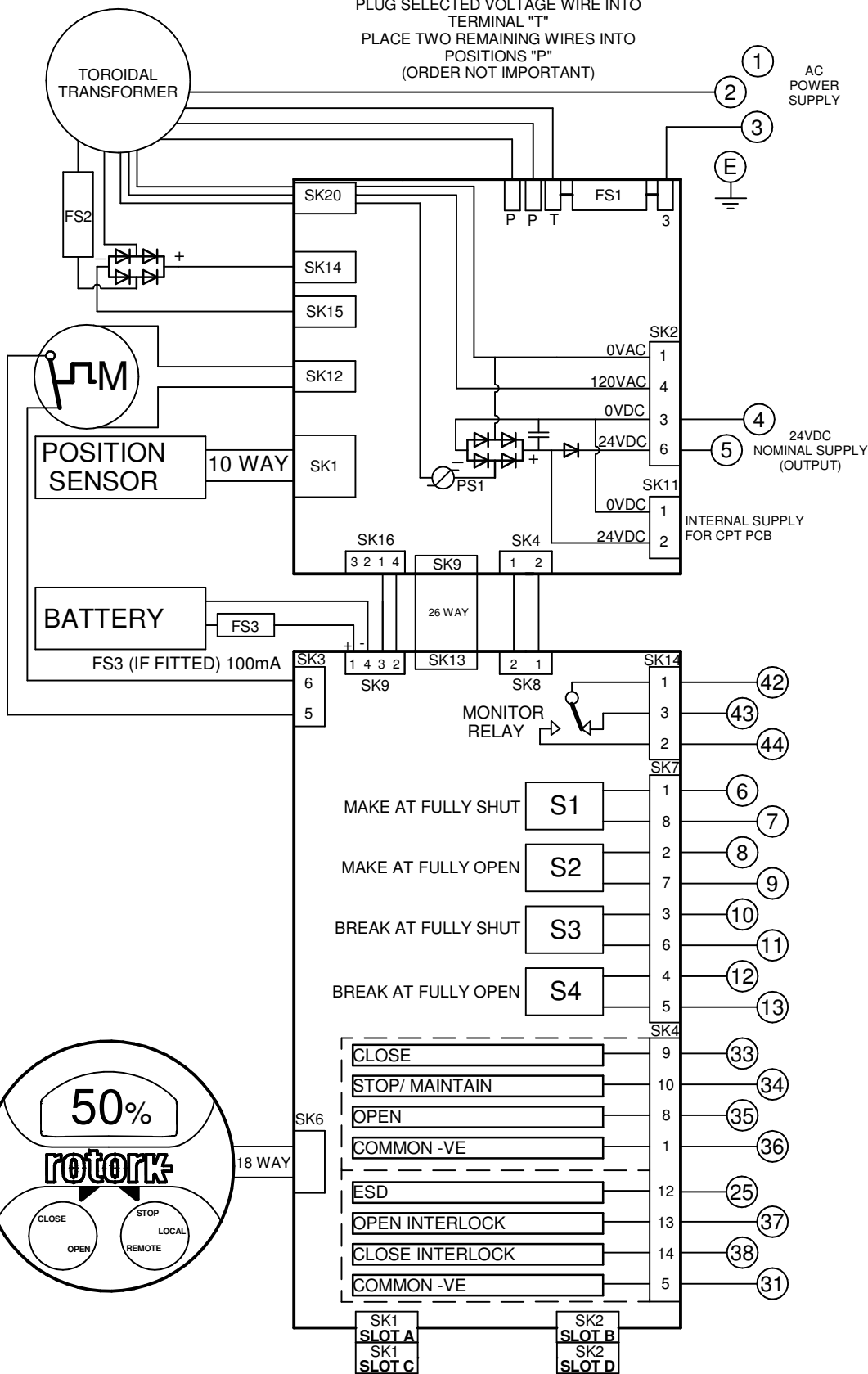

TRANSFORMER VOLTAGE OPTIONS:
CONNECT CORRESPONDING
COLOUR TO "T"

TYPE 1		
GREY	100V	FS1 - 5A ANTISURGE
PURPLE	110V	
BROWN	120V	
TYPE 2		
GREY	200V	FS1 - 2.5A ANTISURGE
PURPLE	230V	
BROWN	270V	
TYPE 3		
GREY	380V	FS1 - 2.0A ANTISURGE
PURPLE	400V	
BROWN	415V	
TYPE 4		
GREY	480V	FS1 - 2.0A ANTISURGE
PURPLE	575V	
BROWN	690V	

FS2 - 20A ATO FAST ACTING ALL TYPES

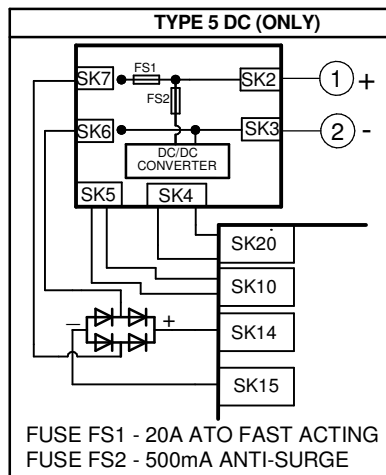

REFER TO SHEET 2 FOR NOTES
& OPTION PCB'S IF FITTED

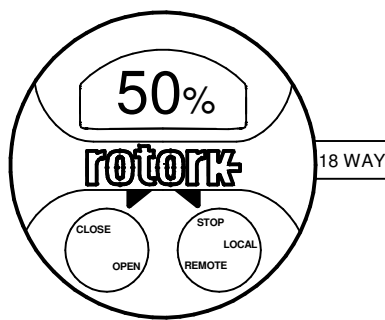

Iss	Date	Chkd	Revision Details
1	090620	JC1	First Issue.

www.rotork.com

IQT + CPT + HART + EXTRA RELAYS S5-S8 + RHS

ROTORK CONTROLS LTD
BATH, BA1 3JQ
ENGLAND
Tel:01225-733200

ROTORK CONTROLS INC
ROCHESTER
NY 14624, USA
Tel:585-247-2304

Drawn by: PJW
Date : 090620
Base WD: 301H2016
Job No : - -
MI No : - -

Circuit Diagram Number		Issue No	Sheet
301H2016		1	1
B1	C1	B2	C2
B1	C1	M1	V1

SLOT A

CIRCUIT DRAWN WITH POWER SUPPLY OFF

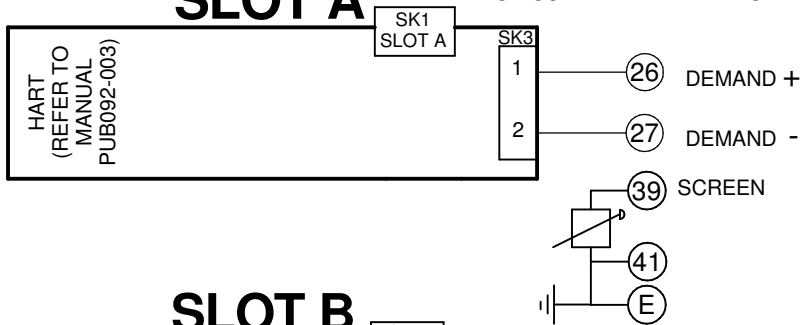

SLOT B

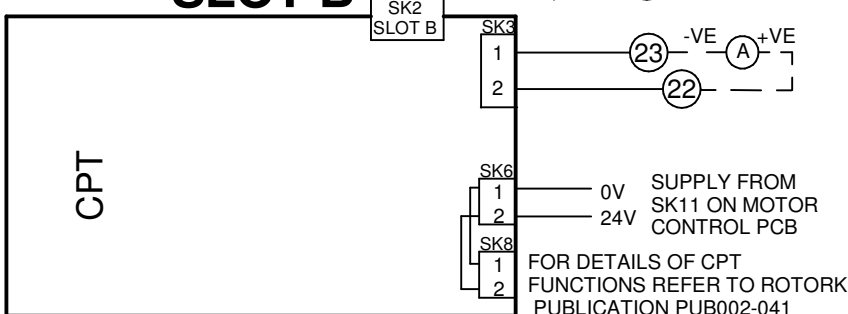

SLOT C

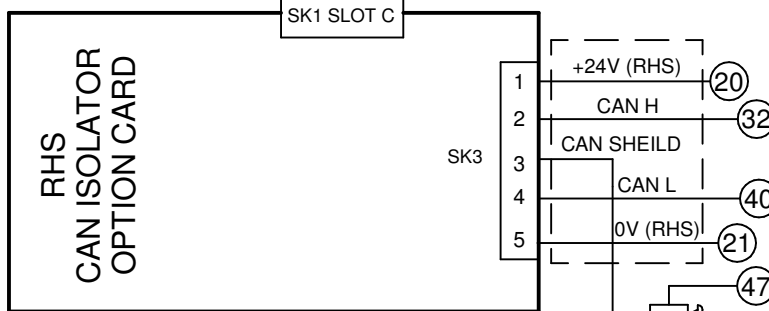

SLOT D

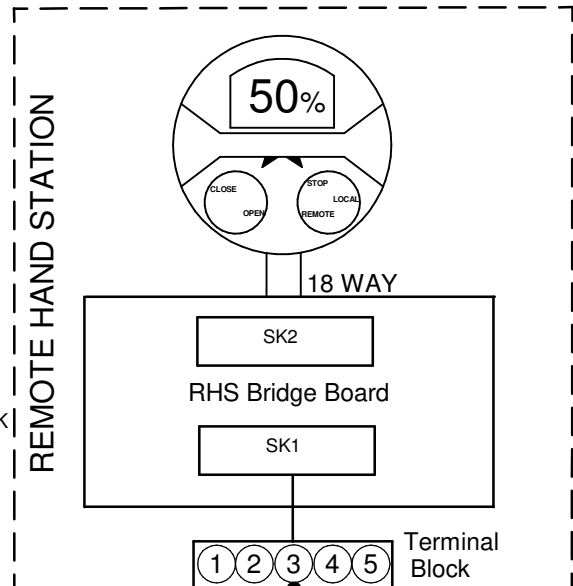
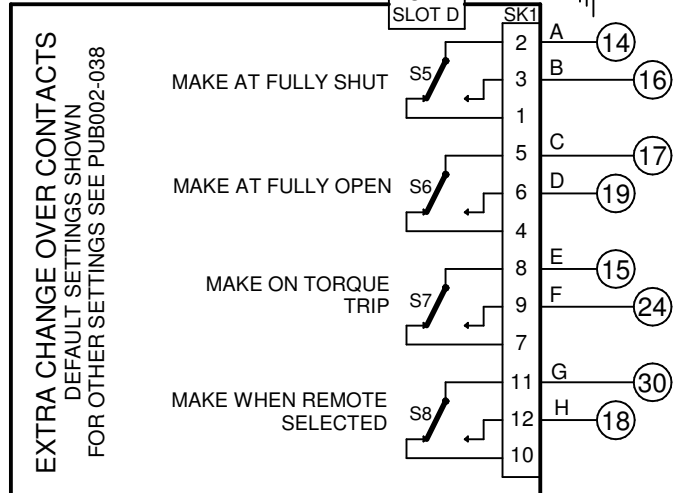

RHS CABLE IS CUSTOMER SUPPLIED, FOR SPECIFICATION SEE PUB002-059, MAXIMUM LENGTH OF CABLE TO BE 100m.

Actuator Terminal Bung No.	RHS Terminal Block No.	Function
20	1	+24V (RHS)
21	2	0V (RHS)
32	3	CAN H
40	4	CAN L
47	5	SHEILD

NOTES

- 1.FUSES:**
- PS1 is a self-resetting fuse.
 - Refer to publication PUB002-065 for approved fuses FS1 and FS2.
 - Actuator rated voltage specified on nameplate. Voltage tolerance +/-10%, applies for rated torque performance; duty cycle is not guaranteed.
- 2.REMOTE CONTROL:**
- For typical remote control circuits refer to:
 - RWS indicated or PUB002-041.
 - For DC and AC control, connect -ve/0V to terminal 36.
 - (For negative switch / positive common, refer to RWS indicated).
 - Control signal threshold voltages:
 - DC: "on" ≥16Vdc / "off" ≤8Vdc, max 60Vdc.
 - AC: "on" ≥60Vac / "off" ≤40Vac, max 120Vac.
 - Control signal duration to be 300ms minimum.
 - Maximum current drawn from remote control signals is:
 - 8mA at 24Vdc or 12mA at 120Vac.
 - Supply provided on terminals 4 & 5:
 - Intended for remote control.
 - Max external load 5W at 24Vdc / 5VA at 120Vac

3.INDICATION:

- For typical position, status and alarm indication see PUB002-041.
- “S” contacts are user configurable and are shown in their default setting.
- Refer to PUB002-040 for functions and configuration instructions.
- Monitor Relay indicates actuator availability for remote control (shown “unavailable”). It can be configured to exclude local/remote selection.
- Refer to PUB002-040 for monitored functions and configuration instructions.
- Voltage applied to indication contacts must not exceed 150Vac
- Individual Switch current must not exceed 3.5A inductive, 5A resistive and no more than 8A in total for all 4 contacts.

4.BATTERY:

- Battery maintains local and remote “S” contact indication only.
- Refer to installation manual for approved replacement battery types.

See Sheet 1 for all Revision details/information

Circuit Diagram Number	Issue No	Sheet
301H2016	1	2
		of 2