

Drawing Number
FORM C EN ISO 5210 DIN 3210

FORM C - ISO 5210/DIN 3210 & DIN 3338

DIMENSIONS		IB2, IB4, HOB4		IB3, IB5, IB6, HOB5, HOB6		IB3, IB5, IB6, HOB5, HOB6		IB7, IB8, HOB7, HOB8		IB7, IB8, HOB7, HOB8		IB9, IB10, HOB9, HOB10		IB9, IB10, HOB9, HOB10		IB11, IB12, HOB11, HOB12		IB12, HOB12		IB13, HOB13	
EN ISO 5210 DIN 3338	DIN 3210	F10	G0	F14	G1/2	F16	G3	F16	G3	F25	G4	F25	G4	F30	G5	F30	G5	F35	G6	F35	G6
h max.		3		4		5		5		5		5		5		5		5		5	
b1 (H11 fit)		14		20		24		24		30		30		40		40		45		45	
Ø d11 (H11 fit)		28		38		47		47		64		64		75		75		105		105	
Ø d11 max.		40		52		52		68		68		76		76		96		96		121	
Ø d12		55		70		70		90		90		110		110		130		130		160	
Ø d12 (DIN3338) (d7 DIN3210)		42		60		80		80		100		100		120		120		160		160	
Ø d12recess		n/a		n/a		80		n/a		100		n/a		120		n/a		160		n/a	
h3 min.		15		20		30		25		20		20		25		25		40		40	
h11 (DIN3338)		7		8		10		10		11		11		13		13		17		17	
h11 max.		18		14		14		20		20		14		24		18		18		18	
h* (DIN3210)		10		12		15		15		16		16		18		18		22		22	
h* max.		20		16		17		23		23		17		27		21		22		22	

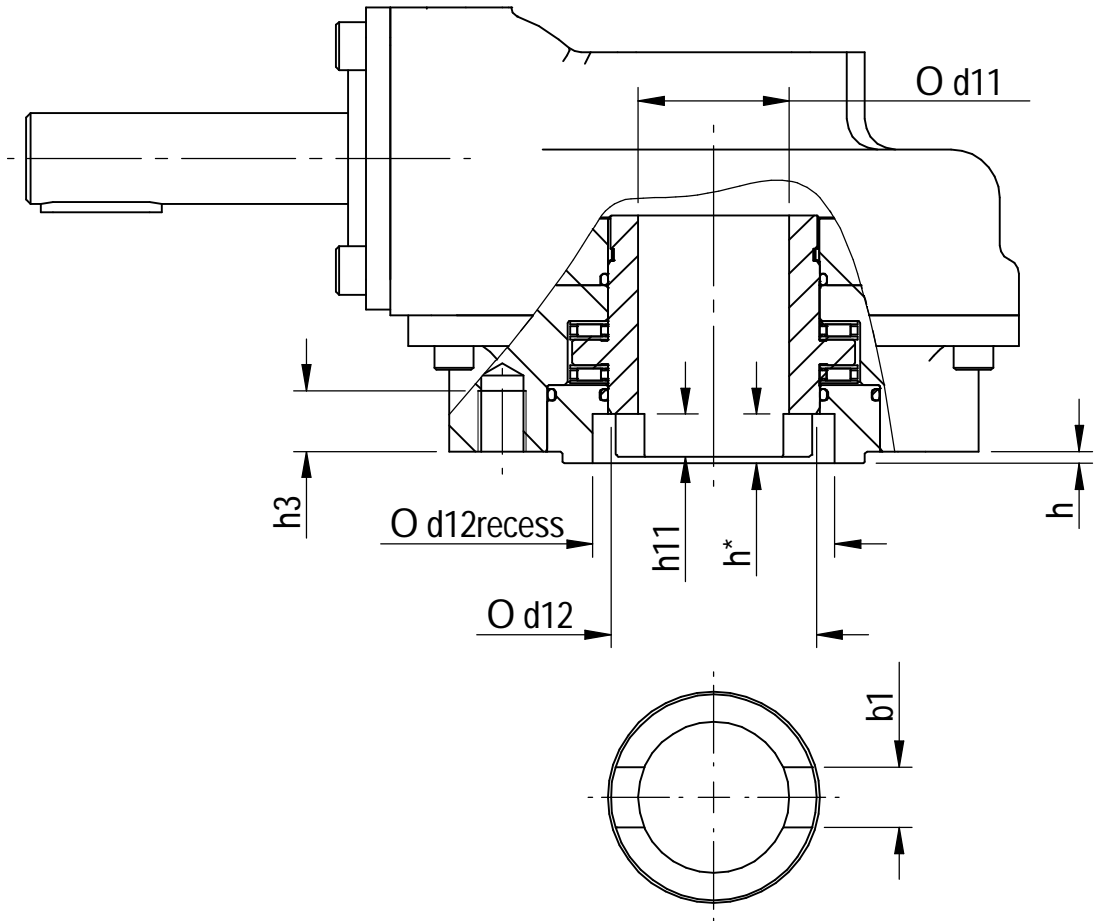

D	J PRIESTLEY			17/06/2015	IB12/HOB12 F35 DETAILS ADDED	
C	J PRIESTLEY			11/06/2015	HOB GEARBOX RANGE ADDED	
B	J PRIESTLEY			30/01/2015	DIMENSION Ø d12recess ADDED	
A	-	-	-	28/08/2014	FIRST ISSUE	
Iss.	EC	Revised	Checked	Approved	Date	Change Description

AS PART OF CONTINUOUS PRODUCT DEVELOPMENT, ALL DETAILS SUBJECT TO CHANGE WITHOUT PRIOR NOTICE. FOR UP TO DATE DETAILS PLEASE VISIT www.rotork.com

<p>Leeds - UK www.rotork.com</p>	<p>This drawing is confidential and is the property of Rotork Gears and must not be reproduced either wholly or partly. All rights in respect of patents, designs and copyrights are reserved. © 2014</p>	Document Type PUBLICITY	Mass	Title	
			Dimensions in mm		BEVEL GEARBOX FORM C EN ISO 5210 DIN 3210 & DIN 3338
			Scale 1:2.5		
Created	J PRIESTLEY	28/08/2014	Drawing Number		Iss.
Checked	C. FLESHER	18/06/2015	FORM C EN ISO 5210 DIN 3210		D
Approved			Sheet 1 of 1	Size A4	