

rotork®

Keeping the World Flowing
for Future Generations

IQ3 Pro range

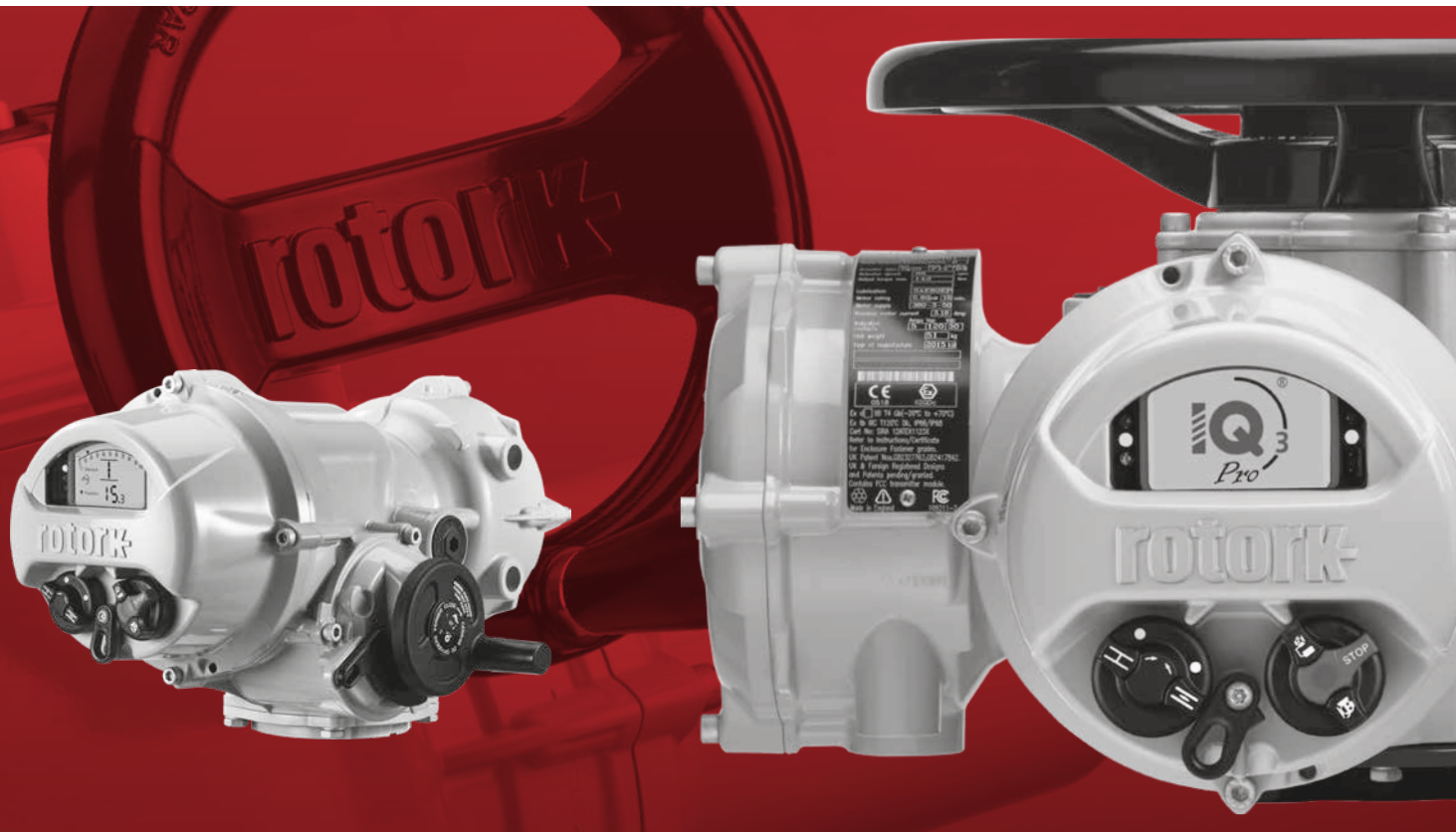

Multi-turn and part-turn electric valve actuators control and monitoring facilities

Section	Page
IQ - In Control	3
Actuator Electrical Specification	4
Control Specification	6
Indication, Monitoring and Data Logging	9
Indication Options	10
Fieldbus Systems	11
Actuator Wiring Diagrams	12
ESD and Interlock Control Circuits	15
Remote Control Circuits	16
Analogue Control Circuits	18
Partial Stroke Function	19



Rotork’s proven IQ range of actuators includes absolute position measurement, large information rich display, enhanced data logging, status and asset management plus additional control and indication features and options. IQ range actuators are self-contained, non-intrusive units for local and remote electrical operation of valves. The IQ3 Pro range of actuators now have additional configuration options to enhance the user experience:

- The Rotork app, which enables configuration using a smartphone
- Manual setup, which enables configuration using the local control knobs



IQ3 Pro multi-turn actuator:

- IQ3 Pro – isolating duty 3-phase power supplies
- IQ3M Pro – modulating duty 3-phase power supplies
- IQ3S Pro – isolating duty 1-phase power supplies
- IQ3D Pro – isolating duty DC power supplies

IQT3 Pro part-turn actuator:

- Intelligent, non-intrusive part-turn actuator incorporating all the benefits of standard IQ3 Pro control and indication features
- Suitable for 3-phase, 1-phase and 24 VDC power supplies
- Operating speed can be varied

The IQT3 Pro range comprises an electric motor, reduction gearing, reversing starter, position and torque limitation with local control and indication, remote control inputs and indication outputs. Actuator enclosures are all double-sealed watertight IP66 and IP68 (7 metres for 72 hours), NEMA 4 and 6. Enclosures suitable for use in hazardous areas are also available.

The following specification covers standard and optional control and monitoring features. Options selected must be specified with order.

IQ3 Pro - the first valve actuator you can commission and interrogate without removing electrical covers. With the Rotork Bluetooth® Setting Tool Pro v1.1, Manual setup, the Rotork app or PC based Insight 2, commissioning and analysis of actuators is simple, fast and convenient.

Rotork Bluetooth® Setting Tool Pro v1.1

All settings including torque, limit and indication contacts are made using the non-intrusive, hand held, Rotork Bluetooth® Setting Tool Pro v1.1, included with each order. Connection to the actuator is made using Bluetooth wireless communication after an initial infra-red log-on to ensure security is maintained. Settings are also password protected.

Using the tool, the on-board data logger and asset information can be viewed on the actuator display. In addition, configuration and data logger files can be extracted from the actuator to the setting tool for transfer to office based PC running Insight 2. The tool is watertight and intrinsically safe so can be used in wet and/or hazardous areas. Data upload/download is non-intrusive via Bluetooth. The tool can store up to 10 data logger files which includes unit configuration file.

If required, a PC running Insight 2 can be directly connected to an actuator to allow set-up, adjustment and analysis.

For more information refer to [PUB095-013](#)

Rotork app

The Rotork app provides a user-friendly interface that allows configuration of IQ3 Pro actuators from a smartphone running Android (version 10 or higher) or iOS (version 15 or higher). For ease of setup, Rotork recommends that you use the configuration wizard in the app to configure actuators.

The Rotork app also provides a set of configuration screens and a setting tool functionality that mimics use of the BTST.

Manual setup

When using manual setup, the menus and commands displayed on the screen are navigated by using the OPEN/CLOSE control knob.

Insight 2 – Actuator configuration and analysis tool for PC

Insight 2 PC software allows all IQ actuator set-up configuration and data logger information to be reviewed, analysed and reconfigured. The visually interactive application is a stand-alone program running under Microsoft Windows™ operating systems. Intuitive and clear menus make analysing data from an IQ simple and fast.

Data logging and configuration

Every actuator includes an on-board data logger. The data logger captures and stores valve, actuator and control signal operation and status data and can be viewed on the actuator display or using Insight 2. It can also be uploaded to Rotork's intelligent Asset Management (iAM) systems. Log data is time and date stamped and can be analysed by playing back on an event by event basis.

In addition, actuator set-up configuration can be viewed and stored using Insight 2 for complete actuator asset management or future upload/replication of other units, such as Rotork's iAM systems.

Features:

- Non-intrusive actuator configuration
- Valve torque profile - open/closed instantaneous and average torque against valve position
- Nameplate data
- Number of operations
- Control option card configuration
- Valve and actuator position starts log
- Operation signal log
- Actuator control status log
- Operational statistics
- Service alarms

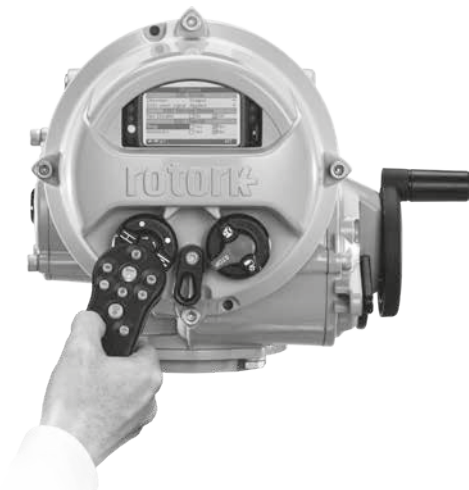

Power supply

The electrical supply type and nominal operating voltage must be specified at time of order. Actuator torque performance is guaranteed with a voltage tolerance +/-10% and frequency tolerance +/- 5%. Actuators are capable of starting and running up to speed with a maximum 15% volt drop.

Non-standard tolerances

Where voltage and/or frequency variations may be experienced outside those quoted below, or where operation under large volt drop conditions may be required, please apply to Rotork.

Non-standard voltages

Actuators can be supplied to operate on power supply voltages other than those quoted above.

Please apply to Rotork.

Uninterruptible power supplies

Standard actuators can be operated on UPS systems providing the above specified tolerances are not exceeded and waveforms, harmonics, spikes etc. adhere to recognised supply standards such as EN50160, NFPA99 or NEC.

IQ3 Pro power supplies

IQ3 Pro and IQ3M Pro – 3-phase power supplies

IQ actuators are available for operation with the following standard 3-phase, three wire, nominal power supplies:

50 Hz

190, 200, 208, 220, 240, 380, 400, 415, 440, 480, 500, 575, 660, 690 Volts

60 Hz

200, 208, 220, 230, 240, 380, 400, 440, 460, 480, 500, 575, 660, 690 Volts

Refer to publication PUB002-038 for IQ actuator performance summary, PUB002-099 for actuator 3-phase isolating duty power supply rating data and PUB002-120 for IQ3M Pro 3-phase modulating duty power supply rating data.

IQ3S Pro – 1-phase power supplies

IQ3S Pro actuators are available for operation with the following standard 1-phase nominal power supplies:

50 Hz

110, 115, 120, 220, 230, 240 Volts

60 Hz

110, 115, 120, 220, 230, 240 Volts

Refer to PUB002-038 for IQS performance summary and PUB002-119 IQS 1-phase power supply rating data.

IQ3D Pro – DC power supplies

IQ3D Pro actuators are available for operation with the following standard DC nominal power supplies:

24 V*, 110 VDC

Refer to publication PUB002-038 for IQ3D Pro performance summary and PUB002-121 for IQ3D Pro DC power supply rating data.

** Limited by actuator size.*

IQ3 Pro actuators

Four threaded conduit entries are provided, tapped: 1 x M40 and 3 x M25. When specified, the actuator will be dispatched with adaptors: 1 x 1 1/2" and 3 x 1" imperial to BS3643, "Ex" certified or as an alternative, 1 x PG29 and 3 x PG16.

IQT3 Pro power supplies

IQT range of actuators is available for the following power supplies without change in performance.

Refer to PUB002-038 for IQT3 Pro performance summary and PUB002-068 IQT range power supply rating data.

IQT3 Pro, IQT3M Pro and IQT3F Pro – 3-phase power supplies

IQT, IQTM and IQTF actuators are available for operation with the following standard 3-phase, three wire, nominal power supplies:

50 Hz

200, 208, 220, 230, 240, 380, 400, 415, 440, 460, 480, 500, 550, 575, 590, 600, 660, 690 Volts

60 Hz

200, 208, 220, 230, 240, 380, 400, 415, 440, 460, 480, 500, 550, 575, 590, 600, 660, 690 Volts

IQT3 Pro, IQT3M Pro and IQT3F Pro 1-phase / 2-phase power supplies

50 Hz

100, 110, 115, 120, 208, 220, 230, 240 Volts

60 Hz

100, 110, 115, 120, 208, 220, 230, 240 Volts

IQT3 Pro, IQT3M Pro and IQT3F Pro – DC power supplies

24 VDC*

24 VDC 'Solar'*

* IQT Pro - 24 VDC: speed may vary with load.

IQT3 Pro actuators

Four threaded conduit entries are provided, tapped: M25. When specified at order an adaptor to 0.75" ASA NPT, or as an alternative, PG16 will be supplied.

Conduit entries

IQ3 Pro / IQT3 Pro range actuators have a separately sealed terminal compartment incorporating a segregated terminal block and cable / conduit entries. It is the responsibility of the installer to ensure the appropriate cable / conduit adaptors, glands and blanking plugs are fitted in order to maintain hazardous area certification and ingress protection rating. Certified adaptors and blanking plugs are available as optional extras.

Terminals

IQ3 Pro / IQT3 Pro range actuators incorporate a terminal block containing segregated metric screw terminal inserts. M5 pan head terminal screws are provided for power terminals and M4 pan head terminal screws for control and indication. The terminal box cover carries a terminal identification code card. Each actuator is supplied with instruction book and wiring diagram.

Wiring

Jig built harnesses of individually numbered stranded conductors, tropical grade PVC insulated, connect internal components to the sealed terminal block. All internal control connections to the printed circuit boards are via plugs and sockets. Wiring of contacts to outgoing terminals are sized for maximum applicable current.

Motor

For motor duty ratings refer to PUB002-038.

Absolute position sensing

Reliable valve position sensing is critical. Using the latest technology and after several years of testing, the patented Rotork absolute encoder is contactless, has only four active parts, can measure up to 8,000 output turns with a resolution of 7.5° and has redundancy and self checking. Unlike existing absolute encoder designs, this technological breakthrough increases position sensing reliability while providing zero-power position measurement.

Protection features

The IQ3 Pro range includes the following protection features:

Torque protection

If the torque produced in operating the valve when closing or opening reaches that set for the active torque switch, the motor will be de-energised. The torque switches are independently configurable in the range 40 - 100% of rated torque. Local and remote indication of torque trip is provided.

Motor over temperature protection

Two thermostats are located within the motor stator. The thermostats will trip and de-energise the motor if the temperature exceeds its rating. Local and remote indication of thermostat tripped is available. The thermostat can be overridden during an ESD operation.

Automatic phase rotation correction

The actuator will always run in the correct direction regardless of the sequence of power supply connection.

Electrical control module

Incorporating a single integrated circuit, hardwired logic control for the actuator together with HMI interface. On board data logger records operational data, valve torque/position profiles and statistical information, all time and date stamped.

Torque switch and position control

Position and torque are adjustable as follows:

IQ Range	
IQ	IQT
Position setting range: 2.5 to 8,000 turns, with a minimum angular resolution of 7.5° at the output.	Position setting range: Electrical limits can be set between 30° and 90°.
Torque switch setting: 40% to 100%	Torque switch setting: 40% to 100%
-	Speed: 25% to 100%

For IQ3 Pro, IQ3M Pro, IQ3S Pro and IQ3D Pro, output torque is obtained via measurement of wormshaft displacement under load and is independent of voltage, frequency and temperature fluctuations.

“Torque off” during unseating or during starting/reversing in mid travel against high inertia loads can be inhibited. A “jammed valve” protection circuit de-energises the motor if no movement occurs after receipt of a signal to open or close.

The IQ3 Pro / IQT3 Pro range incorporates a battery to maintain both local LCD and remote “S” contact indication of actuator/valve status when power to the actuator is isolated. Should manual operation of the valve take place during a power supply interruption, both local and remote indication is updated. Unlike other actuator makes, a secondary low voltage power supply is not required to update local and remote valve position indication.

Expected battery life is up to 5 years for IQ3 Pro and 3 years for IQT3 Pro but will depend on usage and environment. The status of the battery is indicated by the actuator display. Remote indication of battery status is available with actuator “S” contact indication.

All actuator configured settings are stored in non-volatile EEPROM (Electrically Erasable, Programmable Read Only Memory). EEPROM does not require any power supply to maintain the stored configured settings and is therefore completely independent of the battery.



Local control

Non-intrusive selectors are provided on the actuator’s electrical control cover, one for Local/Stop/Remote selection, pad-lockable in each position, and the other for Open/Close control. Local control may be configured for maintained or inching operation.

Controls may be rotated to suit actuator orientation.

Local control may be selected to operate using the supplied setting tool. The setting tool incorporates dedicated Open, Stop and Close buttons and will operate over a nominal distance of 10 metres from the display window.

Vandal resistant local control option

Control selectors removed, indication window with or without removable cover, control of Local, Stop and Remote selection and local Open and Close control is via the setting tool.

Remote control

There are six control inputs for remote control:

- Open, Close, Stop/Maintain/Drive enable
- Emergency Shut Down (ESD)
- Open interlock and Close interlock

Control can be connected for maintained or push to run, “inching” control. Refer to page 16 for remote control circuit schematics.

Remote control inputs are opto-isolated interfaces with a surge immunity of 2 kV. Standard control is positive switching (negative switching is available if specified).

The standard IQ actuator can be controlled using remote control signals defined as follows:

Customer fed control circuit supply:

Within the ranges 16-60 VDC, 60-120 VAC.

Actuator fed control circuit supply:

24 VDC. (120 VAC available if specified).

The current drawn for each control input:

8 mA at 24 VDC, 12 mA at 120 VAC

Minimum “ON” voltage: 16 V,

Maximum “OFF”: 8 V.

Minimum signal duration: 300 ms.

Maximum remote control cable capacitance:

2 µF core to core.

IQ3D Pro and IQT3 Pro – DC actuator remote control

Remote control is available within the ranges 16-60 VDC, 60-120 VAC only. Note: for IQ3D Pro at 110 VDC power supply, the maximum remote control input voltage is 60 VDC.

For applications where the actuator is powered from a power supply of limited capacity such as solar power charged, direct current UPS system, power conservation is of prime importance. The IQD* includes a "solar" feature to minimise power consumption when not operating, reducing the current drawn by the actuator control to 10 mA (maximum). Applying a remote "Open", "Close" or "ESD" control signal or a discreet "wake up" signal causes the actuator to power up its control circuits and after a delay of up to 10 seconds, respond to the remote control signal. Between 3 and 6 seconds after the control signal is removed, the actuator returns to the low current "solar" state.

As part of this routine, in order to save power, the actuator fed 24 VDC remote control supply is disabled when in solar mode. i.e. actuator 24 VDC fed remote control supply is unavailable for applying a signal to power up the actuator control when operation is required and therefore a discreet externally fed "wake up" signal or externally powered control signals must be used.

* IQT3DC Pro Solar is an optional extra.

Three modes of control are available:

- Standard - sleep function disabled, 24 VDC remote control supply available at all times.
- "Solar" sleep function enabled, 24 VDC remote control supply **disabled** when asleep.
- "Solar" sleep function enabled, 24 VDC remote control supply **enabled** when asleep.

Unless otherwise specified, the actuator will be dispatched configured in the "solar" mode of control. Remote control signals must therefore be a minimum of 10 second duration. The 2-wire remote control form is not available (refer to page 17). For Fieldbus system control please apply to Rotork.

In local control and when "awake" but inactive, the actuator will draw approximately 100 mA from a 24 VDC power supply.

Remote control option

For customer fed remote control in the range 60-125 VDC an alternative control circuit is available (IQ3D Pro is limited to 20-60 VDC and 40-120 VAC only).

Emergency Shut Down – ESD

An active ESD signal will override any local or remote control signal. The ESD input operates from a separate common to that used for Open, Close, and Stop remote control signals. Refer to page 15 for ESD circuit options.

The following ESD options can be configured:

- **ESD signal**
Active high (contact making - NO)
Active low (contact breaking - NC)
- **ESD action**
Close, Open, Stayput
- **ESD override**
Motor thermostat*, local stop,
active interlocks, interrupter timer option

Unless specified with order, the actuator will be dispatched set for the following:

Active high signal (contact making - NO), Stayput. ESD will not override motor thermostat, local stop, active interlock or interrupter timer.

* Factory configured. Bypassing the motor thermostat will invalidate hazardous area certification.

Interlocks

External hard-wired interlocks for opening and/or closing can be configured to inhibit local and remote operation until the external contacts are made. Interlock circuits may be added with any of the remote control circuits. The interlock inputs operate from a separate common allowing for isolation between the safety system and operation control system. Refer to page 15 for standard interlock circuit options.

Conditional control

For applications where a high level of control integrity is required the actuator can be configured for "conditional control". In this mode, operation is conditional on two discrete signals being applied. Looking at an example of a "close valve" command, by applying a signal to the "remote close input" and "close interlock input" simultaneously the actuator will operate and close the valve. If only one signal is applied or a signal is lost, the actuator will fail-safe by staying put or stopping. When conditional remote control is configured the interlock inputs are not active in local operation.

Motor enable

The remote stop/maintain input can be configured as a motor enable input; remote electrical operation is prevented unless a dedicated "motor enable" signal is applied. The probability of operation caused by spurious control signals and/or actuator fault can be minimised and therefore integrity increased.

Two levels of increased integrity are available. Level 1 is user configurable from the standard configuration menus. Level 2 is factory enabled and acts directly in hardware to prevent operation and therefore must be specified with order. Drive enable acts in a similar way to interlocks and conditional control, however just a single input is used to control operation in both opening and closing directions.

Analogue control option

The proportional controller enables the valve to be positioned in proportion to an analogue signal. Positioning can take place over the whole valve stroke or a set portion. If manual intervention is required, analogue control can be overridden using the manual/auto input. Refer to page 18 for analogue control connections.

Valve position, derived from the actuator's non-contacting position sensor, is compared with the position demand signal input. The difference (error) triggers the actuator to drive the valve in the direction that cancels the error and therefore the flow, pressure, level or temperature etc. determined by the valve's position is automatically adjusted in proportion to the analogue demand signal. The control loop may be tuned using the controller's deadband, hysteresis and the Motion Inhibit Timer controls.

Application

Motor-driven actuators are suitable for proportional control in automatic control loops in which the system rate of change is relatively slow, and high accuracy continuous modulation is not essential; level controls in water treatment plants are typical applications. Motor operated regulating valves and sluice gates are driven through nut and screw or wormgear mechanisms which must be self-locking and are therefore mechanically inefficient. Frequent operation will cause rapid wear of these components. The control scheme must recognise mechanical system limitations and be tuned to accordingly.

Regulating valve applications

IQ actuators with reversing motor contactors and hammerblow are suitable for up to 60 starts/hour with an average torque not exceeding 33% of rated torque. IQT actuators use solid state DC motor control, suitable for 60 starts/hour.

Modulating valve applications

IQM and IQML actuators with solid state motor control, configurable DC injection motor breaking and direct drive are suitable up to a 1200 starts/hour.

For more information please refer to PUB002-038.

Accuracy

Based on speed not exceeding 29 rpm and output turns ≥ 10 , an accuracy of $\leq 1\%$ may be achieved. The maximum signal change required to cause response in the same direction (i.e. not through deadband) is 1%. Overall accuracy is a function of valve, coupling and actuator inertia and backlash and therefore output speeds should be kept as low as practicable. Rotork do not recommend analogue control with output speeds greater than 29 rpm.

Configuration

Analogue signal types and ranges:

mA: 0-5, 0-10 and 0-20 (4-20); input impedance 220 Ω
Volts: 0-5, 0-10 and 0-20; input impedance 5.7 k Ω

Controller can be configured to close, open or move to the position set for low or high signal input.

Action on loss of signal

Stayput, Move to high or low signal positions.

With live zero current control loops i.e. 4-20 mA, at 50% of the set low signal (2 mA) the controller invokes the set action.

NOTE: As the signal decays, movement toward the set low signal position may occur until it is determined as "lost".

Tuning

- **Deadband**

Deadband range 0% – 25.5%

Used to allow for overrun or demand signal oscillation and so prevent "hunting" or unnecessary movement (movement without effecting a required control change).

For example a 5% deadband will cause the motor to be de-energised once the actual position is within 5% of the demand position. Subsequent inertia will then bring the final position nearer the demand position.

- **Hysteresis**

Hysteresis range 0% – 25.5% but must always be \leq to the deadband setting.

Hysteresis further refines the accuracy of the position controller.

The controller will run the actuator towards the demand position until the deadband position is reached and then continue by the value of the hysteresis setting. The actuator will not restart unless it overshoots and runs outside the deadband or a change places the demand position outside the deadband.

- **Motion Inhibit Timer (MIT)**

MIT range 0 – 255 seconds.

The MIT may be set to prevent the actuator moving excessively or unnecessarily. Oscillating signals and/or response to small signal changes can effectively be filtered out. A delay is set (in seconds) as a period of inactivity after a response to a signal change. The actuator will not move until the MIT has elapsed and the demand signal changes sufficiently to move outside the deadband.

Interrupter timer option - Reduced speed, hydraulic shock or surge prevention

Where the operating time of the valve must be reduced to prevent hydraulic shock or "water hammer", or to prevent surges, the Interrupter Timer option can be included. Pulsed operation with independently adjustable "on" and "off" time periods in the range 2-100 seconds can be selected to operate over any portion of the closing and/or opening valve stroke. The interrupter timer is active for both local and remote control and can be configured to be bypassed under ESD operation if required.

Local position and local monitoring indication

A back-lit dual stacked liquid crystal display gives digital indication from fully Open to fully Closed in 0.1% increments. Four LED's coloured red, green and yellow for indication of Open, Close and intermediate positions respectively are also provided. The display includes a dot matrix display for status and error message reporting.

With the setting tool, actuator torque can also be displayed allowing the valve torque against position to be monitored in real time. Diagnostics are available for monitoring valve, actuator and control system status. The local display can be rotated to suit actuator orientation. LED colours can be reversed. Please specify at time of order.

Remote position and monitoring indication

Four latching, volt free, single pole contacts, S1, S2, S3 and S4 are provided, each one independently configurable using the setting tool to signal one of the following:

- **Valve position**
Fully Open, fully Closed (exact) or any intermediate positions (0-99% open)
- **Status**
Valve opening; Closing; Moving (continuous or pulsing signal); Local stop selected; Local selected; Remote selected; Open or close interlock active; ESD active; Actuator being operated by handwheel
- **Valve alarms**
Motor tripped on torque in mid travel; Motor tripped on torque going open; Going closed; Valve jammed
- **Actuator alarms**
Lost phase; Customer 24 VDC (120 VAC) supply lost; Battery low; Internal failure detected; Thermostat tripped
- **Service alarms**
High torque; High High torque; Maximum number of starts per hour; Total starts; Total turns; Service intervals

Each contact can be configured either 'normally open' or 'normally closed'.

Contact rating

Contacts are nominally rated at 5 mA to 5 A, 120 VAC, 30 VDC. However as long as the switched circuit power remains within the specified limit of 60 W (inductive) or 150 W (resistive), then the following maximum ratings can be achieved: -

Maximum switching Voltage – 120 VAC or VDC

Maximum switching Current – 5 A*

For example, to operate a 48 VDC external relay (inductive), the maximum permissible current that can be switched through S1 – S8 contacts is calculated by the equation $P/V=I$ e.g. $60 \text{ (W)} / 48 \text{ V} = 1.25 \text{ A}$

Unless otherwise specified S contacts will be configured as follows:

- S1 – contact makes at fully Closed
- S2 – contact makes at fully Open
- S3 – contact breaks at fully Closed
- S4 – contact breaks at fully Open

***NOTE:** Maximum total combined current through all four relays must not exceed 8 A.

Monitor relay

An independent relay with a volt-free changeover contact for monitoring actuator electrical availability is provided. Contacts are nominally rated at 5 mA to 8 A, 120 VAC, 30 VDC. However as long as the switching power remains within the specified limit of 170 W (inductive) or 240 W (resistive), then the following maximum ratings can be achieved: -

Maximum switching voltage – 120 VAC or VDC

Maximum switching current – 8 A

The relay will de-energise under any one, or combination, of the following conditions:

- Loss of one or more of the power supply phases
- Loss of control circuit supply
- Local control selected*
- Local stop selected*
- Motor thermostat tripped

* Monitor relay can be configured for faults only and will ignore the local control status.

Data logger

The on-board data logger allows download of historical actuator/valve performance via Bluetooth to PC or intelligent Asset Management (iAM). For hazardous areas the intrinsically safe setting tool is available. Rotork Insight 2 PC software allows data logger information of operational events and statistics all time and date stamped plus valve torque/position profiles, to be analysed. *Refer to page 3.*





Remote valve position analogue indication - CPT

The Current Position Transmitter (CPT) provides a non-contacting internally fed 4-20 mA analogue signal proportional to valve position. Selectable for minimum signal corresponding to fully Closed or fully Open position with automatic zero and span setting. The maximum external impedance that may be connected to the signal is 500 Ohms at nominal supply voltage. Repeatability is within $\pm 1\%$ and linearity $\pm 1\%$ of total valve travel.

Auxiliary powered CPT (not available with IQ3D Pro)

The auxiliary powered CPT maintains analogue position indication when the mains power is switched off. An auxiliary 24 VDC supply is permanently connected to the actuator, which is automatically switched in to provide power to the CPT on mains failure. On re-instating the mains, the auxiliary supply is automatically switched out.

Note: on mains failure, a surge of up to 1 Amp is required to switch in the auxiliary supply. The "power off" quiescent load is nominally 180 mA, but will depend on the options fitted. It is recommended that the 24 V auxiliary supply is permanently applied to the actuator to limit switch surge current.

Remote valve torque analogue indication - CTT

The Current Torque Transmitter (CTT) provides a non-contacting internally fed 4-20 mA analogue signal proportional to actuator output torque (0-120% of rated torque). When stationary the CTT output will continue to indicate the current torque.

Extra indication contacts

The extra indication contacts option provides up to eight additional changeover contacts, S5-S8 and S9-S12. Each contact is latching, volt free and rated at 5 mA to 5 A, 120 VAC, 30 VDC. The extra indication contact functions are independently configurable in the same way as the standard contacts using the setting tool. The extra indication contact functions can be configured to the same functions as S1-S4. Refer to page 9.

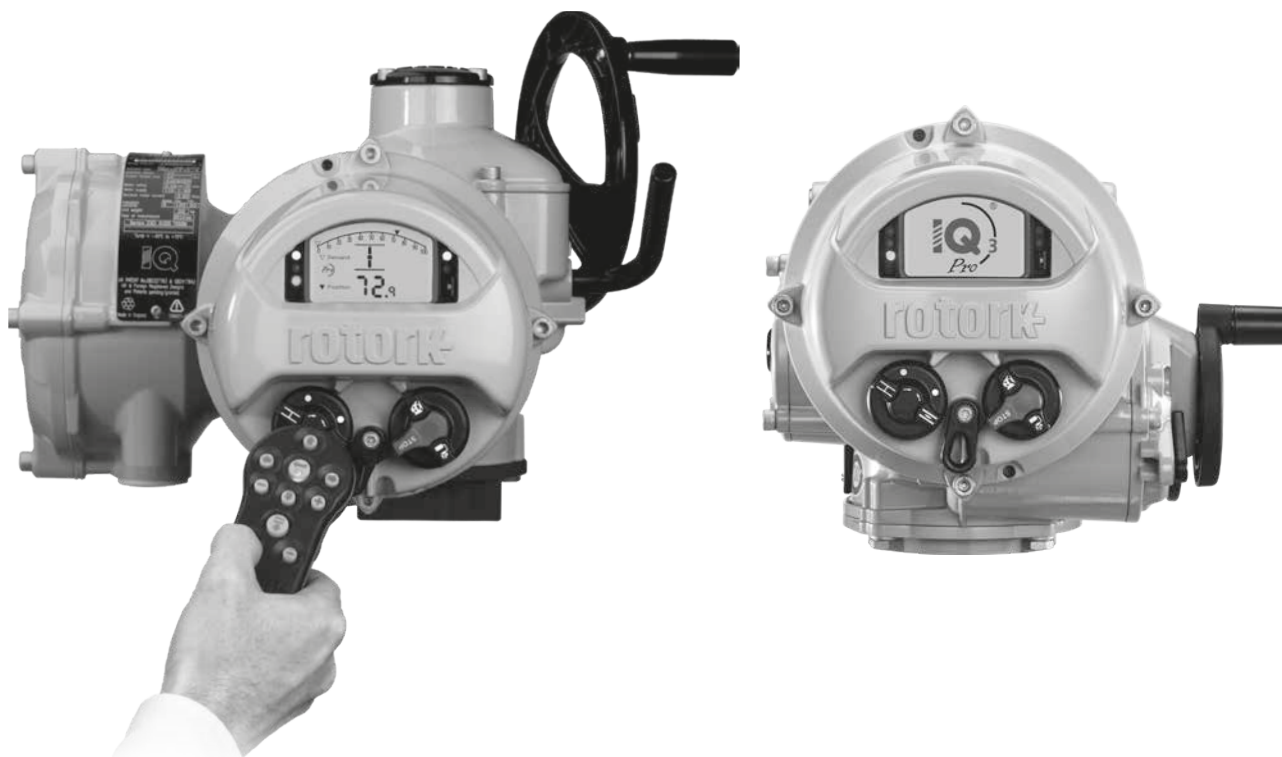

Pakscan™

Rotork's own 2-wire system for control and data transmission to and from the actuators.

An internally mounted Pakscan field unit connects the actuator to the field network. By arranging the field cable in a loop the system automatically provides a fault tolerant redundant path for the data signals. The communication distance may be up to 20 km in length without the need for repeaters, up to 240 actuators may be connected to the loop and a master station supervises the system. Communication from the master station to the host uses Modbus protocol over RS-232 and RS-485. System settings for the actuator are programmable over the Bluetooth data link.

Please refer to PUB059-030.

Modbus®

Single or dual Modbus modules may be included in the actuator to provide remote serial communication to the control functions and for status feedback data. The field network uses an RS-485 data highway, either 2 or 4 wire, and can be duplicated where redundancy is required. The communication is half duplex and the protocol used is Modbus RTU with data rates up to 38 K baud. The actuator variables necessary to set up the system are programmable over the Bluetooth data link.

Please refer to PUB091-003.

Profibus®

Profibus connectivity is possible by fitting the Profibus DP interface module within the actuator. This allows the actuator to be integrated into a standard Profibus network. Full compatibility with the fieldbus standard EN 50170 is provided and the module carries Profibus certification for inter-operability. The network allows full control of the actuator and feedback of status data to the host. The Rotork Profibus module has two communication ports to facilitate redundant fieldbus wiring where reliability is paramount, data rates up to 1.5 M baud are supported.

Please refer to PUB088-001.

Foundation Fieldbus®

Actuators may be connected to a Foundation Fieldbus network (H1) by the inclusion of a Rotork FF-01 module. The device complies with fieldbus standard IEC 61158-2, using a 2-wire electrical connection to the highway and has been certified for inter-operability. The Foundation highway exchanges data and control between devices and full actuator functionality is available. Each actuator has full link scheduler capability complete with function blocks for analogue and digital inputs/outputs in addition to the standard transducer block. Foundation fieldbus networks are capable of operating without a host system as a supervisor, allowing the field devices to communicate directly between themselves.

Please refer to PUB060-007.

HART®

HART (Highway Addressable Remote Transducer) is a process control communication protocol. The signal consists of two parts, the analogue 4-20 mA current loop and a superimposed digital signal. Traditionally the 4-20 mA loop is used for control and the superimposed digital signal for feedback, diagnostics and configuration. Configuration and feedback using the HART digital signal can be achieved using the host connected to the actuator to select the parameters required. The majority of the user configurable settings can be made over the HART communication protocol.

Please refer to PUB092-001.

Additional inputs and outputs

When used in conjunction with a fieldbus network the actuator can also collect additional feedback information from other devices in the field such as level switches or proximity detectors. It is also possible with some systems to provide additional output control functions to operate remote equipment, pump starters etc. In order to provide these features the actuator requires the Fieldbus Remote I/O option which includes 4 digital inputs for feedback data and 4 dry contact relay outputs for control.

Refer to Publication PUB058-001 Rotork Network Compatibility for more information and links to other network documentation.



IQ3 Pro actuator basic circuit diagram 100B0000, drawn in mid-travel, power off
For IQT3 Pro actuator basic circuit diagram refer to 300B0000

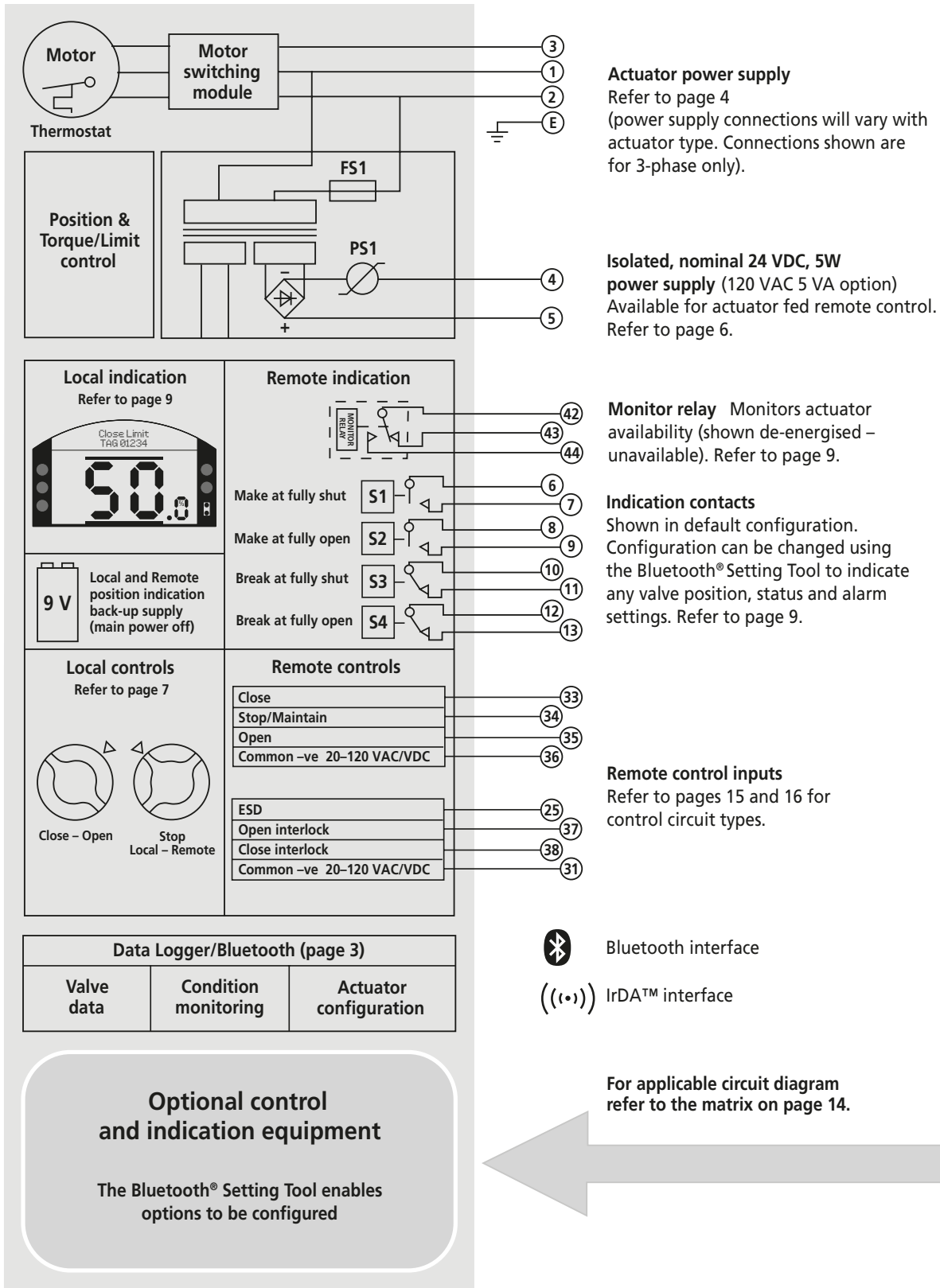

NOTE: Terminal numbers subject to change - Refer to supplied circuit diagrams.

Optional control and indication equipment



Extra indication contacts

Shown in default configuration. Configuration can be changed using the Rotork Bluetooth® Setting Tool Pro v1.1 to indicate status various valve and actuator position, and alarm settings. Contacts are shown in not true state. Refer to page 10

Analogue position control
Folomatic

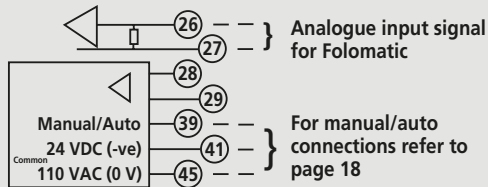

Valve position – CPT

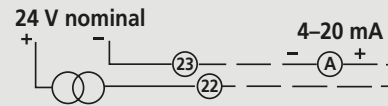

Valve torque – CTT

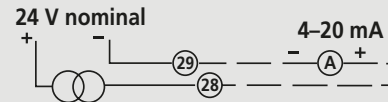

Pakscan
2-wire loop

Care should be taken to ensure that circuits connected to terminals 4 or 5 are not connected directly or indirectly to ground.

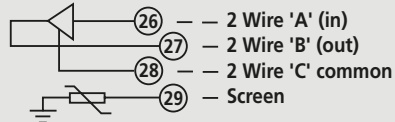

Profibus
RS485 highway

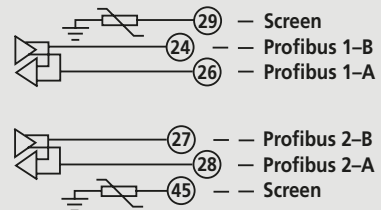

Modbus
2-wire/4-wire RS485 highway

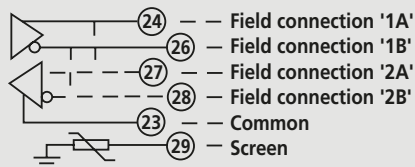

Foundation Fieldbus
IEC61158–2 highway

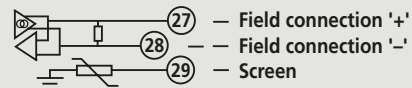

NOTE: Terminal numbers subject to change - Refer to supplied circuit diagrams.

Standard control and indication options

Basic IQ3 Pro range actuator circuit diagram 100B0000 (for IQT3 Pro range 300B0000) include local control and indication, remote open/stop/close, ESD and interlock control and four configurable indication contacts.

Type / Duty	1	0	0	B	0	0	0	0
1 IQ3 Pro standard								
2 IQ3 Pro modulating								
3 IQT3 Pro standard								
4 IQT3M Pro modulating								
5 IQ3 Pro standard Japan								
6 IQ3M Pro modulating Japan								
Power supply								
0 IQ3 Pro 3-Phase/IQT3 Pro with 24 VDC customer supply								
1 IQ3 Pro 3-Phase/IQT3 Pro with 120 VAC customer supply								
2 IQ3 Pro 1-Phase with 24 VDC customer supply								
3 IQ3 Pro 1-Phase with 120 VAC customer supply								
4 IQ3DC Pro with 24 VDC customer supply								
5 IQ3DC Pro/IQT3DC Pro solar with 24 VDC customer supply								
8 IQT3 Pro backup (EXTERNAL SUPPLY)								
9 IQT3 Pro backup (INTERNAL BATTERY)								
Analogue 4-20mA								
0 None								
1 Position indication (CPT)								
2 Torque/position indication (CTT/CPT)								
3 Position control/indication (Folomatic/CPT)								
4 Analogue monitoring (network only)								
5 Position indication (CPT) loop powered								
6 Torque/position indication (CTT/CPT) loop powered								
7 Position control/indication (Folomatic/CPT) with loop powered CPT								
8 2 x Analogue monitoring (Pakscan only)								
Network								
B Basic no network control (hardwired only)								
D DeviceNet 2-wire digital control								
F Foundation Fieldbus 2-wire digital control								
H HART 2-wire analogue control/digital feedback								
K Pakscan 2-wire digital control								
M Modbus 2-wire digital control								
P Profibus 2-wire digital control								
Network options								
0 None								
1 Auxiliary power (no network fitted)								
2 Single channel								
3 Dual channel								
4 Repeater (Modbus only)								
5 Single channel (auxiliary powered)								
6 Dual channel (auxiliary powered)								
Remote options								
0 None								
1 Negative switching remotes (positive common)								
2 BBC remotes (isolated commons)								
3 125 VDC remotes								
Indication options								
0 None								
1 Extra relay contacts S5-S8 (4 additional contacts)								
2 Extra relay contacts S5-S12 (8 additional contacts)								
Accessories								
0 None								
1 Interrupter timer (2 speed timer)								
2 Plug & socket								
3 Interrupter timer and plug & socket								
4 Disconnect module								
5 Interrupter timer and disconnect module								
6 Remote Hand Station								
7 Remote Hand Station and interrupter timer								
8 Remote Hand Station and plug & socket								
9 Remote Hand Station, interrupter timer and plug & socket								

NOTE: Subject to change - Refer to Rotork with your requirement.

ESD and interlock control circuits may be added to any of the remote or analogue circuits shown on pages 16-18.

Emergency Shut Down (ESD) signal will override any existing local or remote signal. The actuator can be configured to open, close or stayput as a response to an ESD signal. ESD signals must be derived from a latching contact. The actuator can be configured to respond to an ESD from a “making” or “breaking” contact.

If required, ESD operation can be configured to override the motor thermostat, local stop, active interlocks or Interrupter Timer option. Overriding the motor thermostat during ESD will invalidate hazardous area certification.

Unless specified with order the actuator will be dispatched set for the following: Active high signal (contact making), Stayput on ESD. ESD will not override motor thermostat, local stop, active interlock or interrupter timer.

Changes in ESD configuration are made using the supplied setting tool.

Interlock circuit control

The default setting is for the interlock function turned OFF. If interlock facilities are required the setting tool can be used to configure the interlocks ON.

Interlocks are active in both local and remote control. If only one interlock is required, the other must be linked out as shown.

Traditional hard-wired interlock systems between actuators such as “Main and Bypass” in steam plant can be easily arranged using the IQ “S” contacts to derive the permissive control signal.

Key

- ④ 24 VDC -ve / 120 VAC N
- ③① ESD/IL common 20-60 VDC and 60-120 VAC
- ③⑦ Open interlock
- ③⑧ Close interlock
- ⑤ 24 VDC +ve / 120 VAC

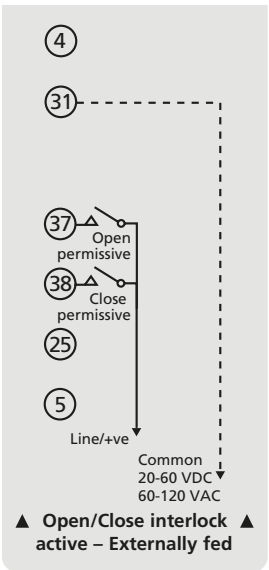
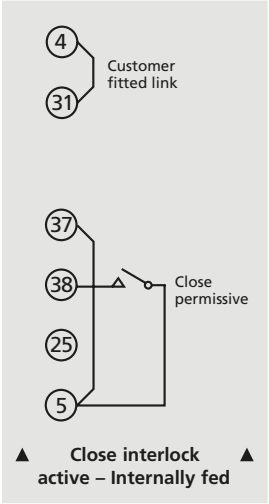
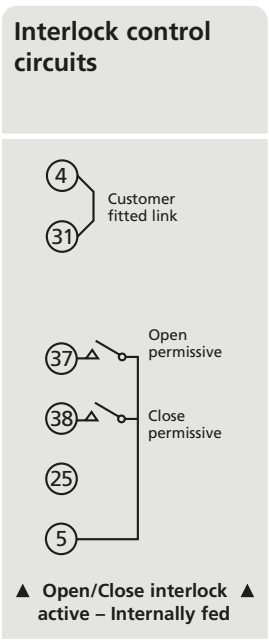
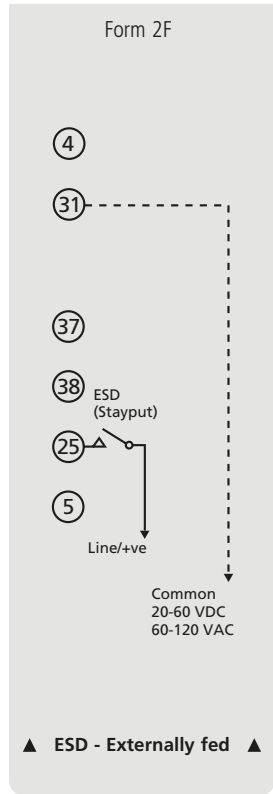
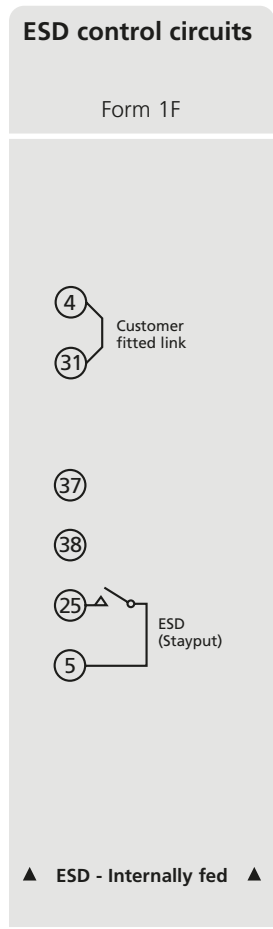

NOTE: Terminal numbers subject to change - Refer to supplied circuit diagrams.



Remote control system wiring schematics for standard IQ3 Pro / IQT3 Pro are shown opposite.

Standard actuators are dispatched without terminal links.

A commissioning bag located in the terminal compartment includes terminal screws, spare cover o-rings, actuator circuit diagram, and the applicable instruction manual (PUB002-039 or PUB002-065).

Remote control inputs are opto-isolated interfaces with a surge immunity of 2 kV. Standard control is positive switching (negative switching is available if specified).

The standard IQ3 Pro actuator can be controlled using remote control signals defined as follows:

Customer fed control circuit supply: Within the ranges, 20-60 VDC or 60-120 VAC.

Actuator fed control circuit supply: 24 VDC, 5 W rated. (120 VAC, 5 VA available if specified).

The current drawn for each control input:

8 mA at 24 VDC, 12 mA at 120 VAC.

Minimum "ON" voltage: 16 V.

Maximum "OFF": 8 V.

Minimum signal duration: 300 ms.

Maximum remote control cable capacitance: 2 µF core to core.

Internal supply -ve (zero) ▶
Common for remote controls on 20 to 60 VDC or 60 to 120 VAC ▶

Close ▶

Stop/maintain ▶

Open ▶

Internal 24 VDC supply +ve (or internal 120 VAC) ▶

Internal supply -ve (zero) ▶
Common for remote controls on 20 to 60 VDC or 60 to 120 VAC ▶

Close ▶

Stop/maintain ▶

Open ▶

Internal 24 VDC supply +ve (or internal 120 VAC) ▶

Open/Close push-to-run control.

Form 1A

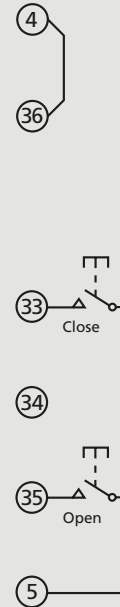

Form 2A

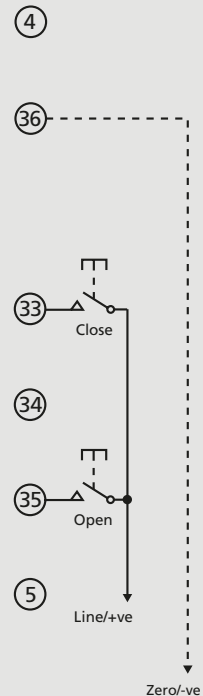

NOTE: Terminal numbers subject to change - Refer to supplied circuit diagrams.

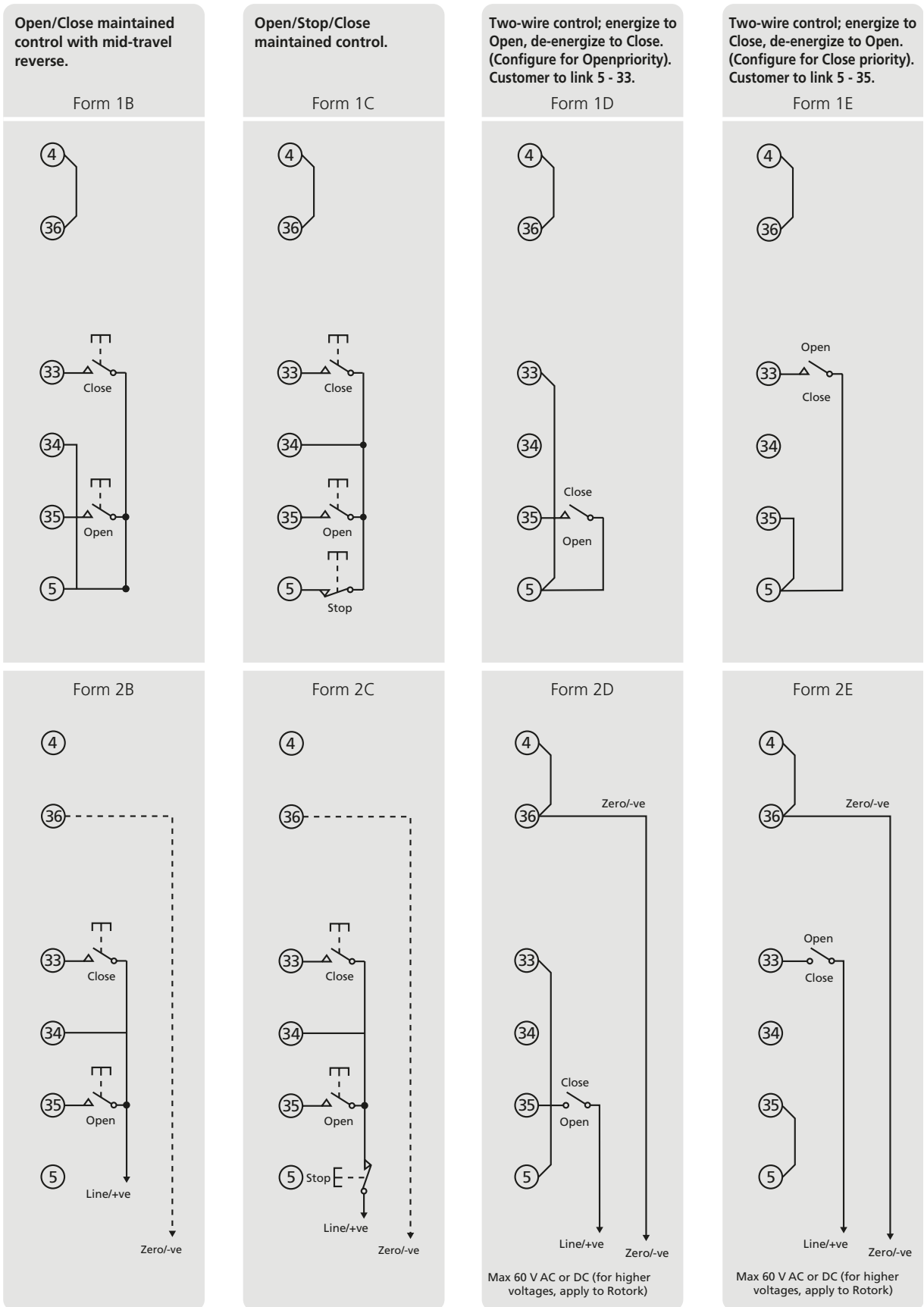

Analogue Folomatic control only

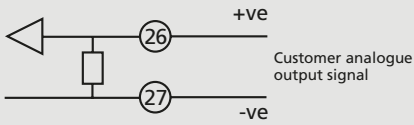

Key

- ②⑥ Folomatic +ve
- ②⑦ Folomatic -ve
- ⑤ 24 VDC +ve
- ④ 24 VDC -ve
- ③⑥ Control common 20-60 VDC or 60-120 VAC
- ④① Folomatic common 20-60 VDC
- ④⑤ Folomatic common 60-120 VAC
- ③⑨ Folomatic manual/auto
- ③③ Remote manual Close
- ③⑤ Remote manual Open
- ③④ Remote manual Stop/Maintain

Analogue Folomatic control with internally fed remote manual override

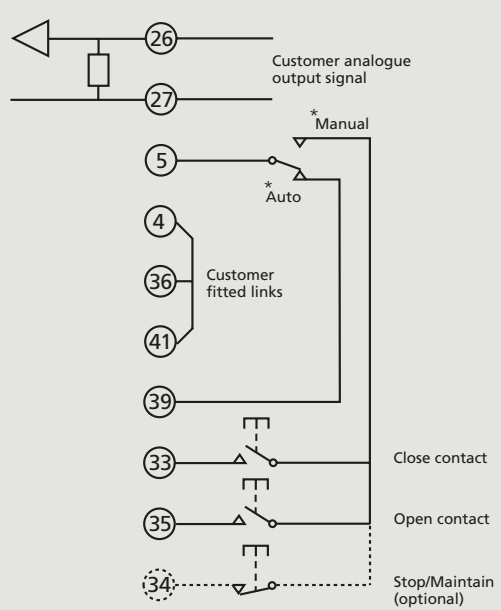

Analogue Folomatic control with externally fed remote manual override

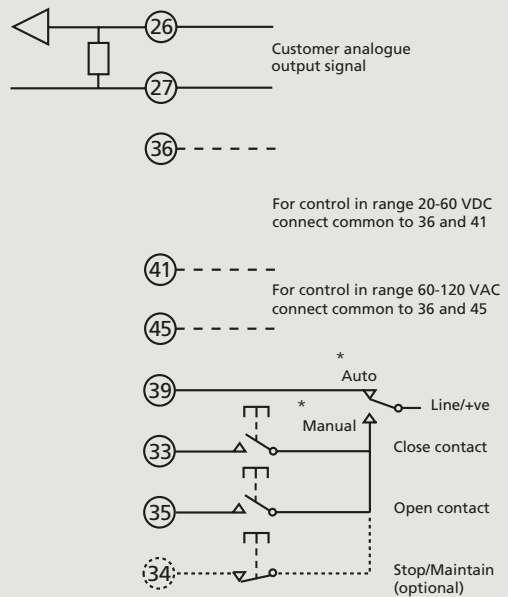

* If Manual/Auto override is required this must be enabled in the configuration menus

NOTE: Terminal numbers subject to change - Refer to supplied circuit diagrams.

The actuator can be set to perform a partial stroke test upon a valid signal being applied to the Open Interlock. This allows for systems to be tested periodically without interruption, to verify valve movement.

The partial stroke function is enabled by selecting partial stroke in the interlock menu. Further partial stroke functions such as Partial Stroke – Limit, Position and Timeout can then be adjusted to suit the application. As the function uses the Open Interlock, the interlock function cannot be used with partial stroking.

For extra diagnostic coverage, there are two new relay configurations that can be used – Partial Stroke Active and Partial Stroke Error, which can be found in the relay setting menu, refer to PUB002-040 for further details.

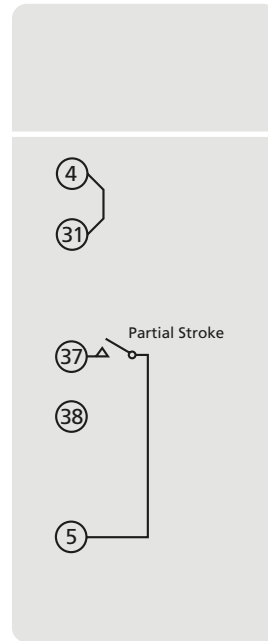

Key

- ④ 24 VDC -ve / 120 VAC N
- ③① ESD/IL common 20-60 VDC or 60-120 VAC
- ③⑦ Open interlock
- ③⑧ Close interlock
- ⑤ 24 VDC +ve / 120 VAC L

NOTE: Terminal numbers subject to change - Refer to supplied circuit diagrams.

rotork®



www.rotork.com

A full listing of our worldwide sales and service network is available on our website.

Rotork plc
Brassmill Lane, Bath, UK
tel +44 (0)1225 733200
email mail@rotork.com

PUB002-200-00
Issue 05/24

As part of a process of on-going product development, Rotork reserves the right to amend and change specifications without prior notice. Published data may be subject to change. For the very latest version release, visit our website at www.rotork.com

The name Rotork is a registered trademark. Rotork recognises all registered trademarks. The Bluetooth® word mark and logos are registered trademarks owned by Bluetooth SIG, Inc. and any use of such marks by Rotork is under license. Published and produced in the UK by Rotork. POLTG0124