

# rotork®

Keeping the World Flowing  
for Future Generations

IQT range 

Instructions for safe use, installation,  
basic setup and maintenance

 **This manual contains important safety information. Please ensure it is thoroughly read and understood before installing, operating or maintaining the equipment.**

PUB002-065-00  
Date of issue 08/24

UK  
CA 

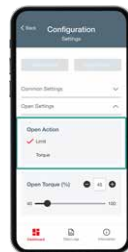

# Table of Contents

<b>1. Introduction</b> _____	<b>3</b>	5.3 Machining the Drive Bush.....	15	8.6 Close Settings.....	26
1.1 Identifying Actuator Parts.....	4	5.4 Fitting the Drive Bush.....	15	8.7 Open Settings.....	27
1.2 Identifying IQT Actuator Type.....	5	<b>6. Mounting the Actuator</b> _____	<b>16</b>	8.8 Breakout Torque.....	27
1.3 Setting Options.....	6	6.1 IQT Actuators.....	16	<b>9. Maintenance, Monitoring and Troubleshooting</b> _____	<b>29</b>
1.4 Rotork App.....	6	6.2 IQTM Actuators.....	16	<b>10. Decommissioning and Environmental Considerations</b> _____	<b>31</b>
1.5 Rotork Setting Tool.....	7	6.3 IQTF Actuators.....	16	<b>11. Weights and Measures</b> _____	<b>32</b>
<b>2. Health and Safety</b> _____	<b>8</b>	6.4 Lifting the Actuator.....	16	<b>12. IQT Approvals</b> _____	<b>32</b>
2.1 ATEX, IECEx, UKEX and CSA Japan Certified Actuators.....	10	6.5 Securing Actuator to Valve.....	17	<b>13. Approved Fuses</b> _____	<b>35</b>
2.2 Indian Ex Certified Actuators.....	10	6.6 Stop Bolts.....	17	<b>14. Vibration, Shock and Noise</b> _____	<b>35</b>
<b>3. Storage</b> _____	<b>10</b>	<b>7. Cable Connections</b> _____	<b>18</b>	<b>15. Conditions of Safe Use</b> _____	<b>36</b>
<b>4. Operating your IQT Actuator</b> _____	<b>11</b>	7.1 Terminal Block Layout.....	18	15.1 Thread details for ATEX, IECEx and UKEX approved actuators.....	36
4.1 Operating by Hand.....	11	7.2 Earth/Ground Connections.....	18	15.2 Maximum constructional flamepath gaps for ATEX, IECEx and UKEX approved actuators.....	36
4.2 Operating Electrically.....	11	7.3 Removing Terminal Cover.....	18	<b>16. IQT Shutdown Battery Operating Conditions</b> _____	<b>37</b>
4.3 Display – Local Indication.....	12	7.4 Cable Entry.....	19	16.1 Shutdown Battery Commissioning.....	38
4.4 Display – Home Screen Selection.....	13	7.5 Connecting to Terminals.....	19		
4.5 Display Status Indication – Travel.....	14	7.6 Replacing Terminal Cover.....	19		
4.6 Display Status Indication – Control.....	14	<b>8. Commissioning - Basic Settings</b> _____	<b>20</b>		
4.7 Display Alarm Indication.....	14	8.1 Connecting to the Actuator Using Rotork Setting Tool.....	21		
4.8 Battery Alarm.....	14	8.2 Connecting to the Actuator Using Manual Setup.....	22		
<b>5. Preparing the Drive Bush</b> _____	<b>15</b>	8.3 Security – Password.....	23		
5.1 Bases F05 to F07 and FA05 to FA07.....	15	8.4 Basic Settings Menu.....	24		
5.2 Bases F10 to F16 and FA10 to FA16.....	15	8.5 Basic Settings – Limits.....	25		

## 1. Introduction

This manual covers IQT3 and IQT3 Pro actuators:

- IQT Operation of isolating/regulating 1/4 turn valves
- IQTM Operation of modulating 1/4 turn valves
- IQTF Operation of part-turn and slow speed multi-turn valves for modulating duty

This manual provides instruction on:

- Manual and electrical (local and remote) operation
- Preparation and installation of the actuator onto the valve
- Basic commissioning
- Maintenance

**Refer to publication PUB002-067 for repair, overhaul and spare part instructions.**

**Refer to publication PUB002-040 for secondary function configuration instructions.**

Using one of the Setting Options identified in Section 1.3 to access the actuator set up procedures, non-intrusive setting of torque levels, position limits and all other control and indication functions can be made safely, quickly and conveniently, even in hazardous locations. The IQT allows commissioning and adjustment to be carried out with the main power supply to the actuator switched on or off.

**The setting tool is packed in the shipping box identified with a yellow label.**

Visit our website at [www.rotork.com](http://www.rotork.com) for more information on the IQT, Insight 2 and other Rotork actuator ranges.



## 1.1 Identifying Actuator Parts

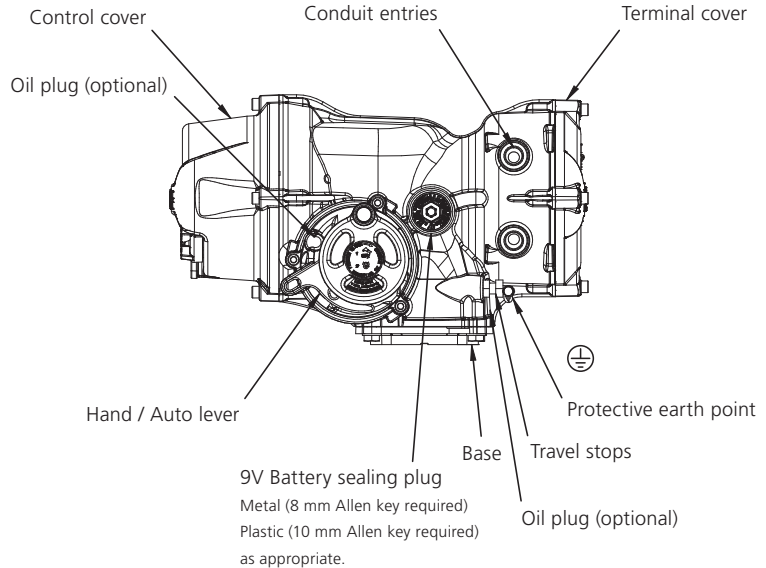
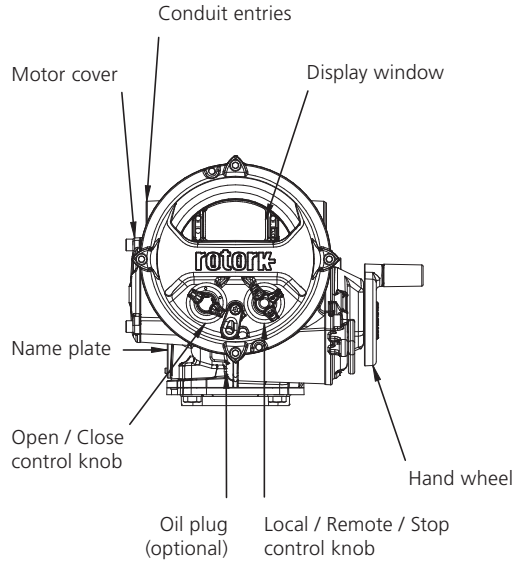

## 1.2 Identifying IQT Actuator Type

### 1.2.1 IQT3 Actuator

Start-up screen shows IQ3 logo

Screen surround is black



### 1.2.2 IQT3 Pro Actuator

Start-up screen shows IQ3 Pro logo

Screen surround is red



OPEN/CLOSE control knob has positioning dots

### 1.3 Setting Options

There are three methods of configuring IQT3 actuators:

1. The Rotork app for smartphones (for IQT3 Pro only). See Section 1.4.
2. The Rotork Bluetooth® Setting Tool Pro (BTST) handset. See Section 1.5.
3. Manual setup using local control knobs on the actuator (for IQT3 Pro only). See Section 8.2.

### 1.4 Rotork App

The Rotork app provides a user-friendly interface that allows configuration of IQT3 Pro actuators from a smartphone running Android or iOS. For compatible versions with your device please check the app store.

For ease of setup, Rotork recommends that you use the Configuration Wizard in the app to configure actuators.

The Rotork app also provides a set of configuration screens and a Setting Tool functionality that mimics use of the BTST.

#### 1.4.1 Smartphone Connection via Bluetooth Wireless

As default from the factory, to connect a smartphone to the IQT3 Pro actuator, first make the actuator discoverable via Bluetooth wireless:

**⚠ Place the LOCAL/STOP/REMOTE control knob into STOP or REMOTE before proceeding.**

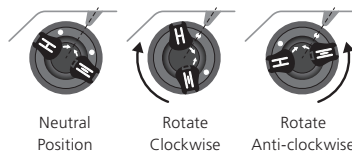

Fig. 1.4.1 OPEN/CLOSE local control knob

Move the OPEN/CLOSE control knob  $\frac{1}{8}$  turn clockwise **or** anti-clockwise, aligning one white dot with the notch on the casting. Hold it in this position for 2 seconds until the blue LED starts to flash, then release the knob.

The actuator will remain discoverable via Bluetooth wireless for approximately 2 minutes, during this time you can connect your smartphone following your phone's Bluetooth pairing instructions and start using the app.

If the actuator reverts to non-discoverable mode, repeat the instructions above.

#### 1.4.2 Rotork App Security

Communication between the smartphone and actuator is by Bluetooth wireless.

Access is granted using "PIN Pairing". When connection is made between the app and actuator, a PIN appears on the actuator screen which must be entered on the app to access the actuator configuration.

**⚠ The Rotork app and manual setup can also be enabled/disabled separately.**

**⚠ IQT3 actuators can be set to different levels of security. For explanations of the available security levels and instructions to implement them, see PUB002-040 IQ Range full configuration, status and monitoring user manual.**

## 1.5 Rotork Setting Tool

The Rotork Bluetooth® Setting Tool Pro v1.1 (BTST) combines the legacy IR and IrDA communication protocols with the latest Bluetooth wireless technology. IR / IrDA support for older Rotork products is retained for use as an IR communication tool. Refer to PUB002-003 and PUB002-004 for details.

The BTST is able to connect to Rotork Bluetooth wireless enabled actuators and related software to set up and complete missions. Missions are configurable sequences of instructions that are to be initiated and controlled by the BTST on an actuator and include (but are not limited to) downloading configuration and data logger files as well as uploading specific configurations to the actuator. Different missions can be programmed into the BTST via Insight 2.



Rotork Bluetooth® Setting Tool Pro v1.1

### Specification

Enclosure: IP54

The BTST has been built in accordance with the following standards:



II 1G  
Ex ia IIC T4 Ga  
CML 19ATEX2194  
IECEx CML 20.0054



CML 21UKEX2122



Ex ia  
Class 1, Div 1,  
Group A, B, C, D T4  
CSA19CA80005457



Ex ia IIC T4 Ga  
GB 3836.1-2021,  
GB 3836.4-2021  
GYJ20.1173X



Ex ia IIC T4 Ga  
CSAUK 20JPN025  
JNIOSH-TR-46-1(2015)  
JNIOSH-TR-46-6(2015)



Ambient Temperature Range:

T<sub>amb</sub> = -30 to +50 °C

Operating Range: Infrared 0.75m,  
Bluetooth 10m

Enclosure Materials: Polycarbonate  
resin containing 10% Carbon Fibre,  
Silicone Rubber

### Instructions for Safe Selection, Installation, Use, Maintenance and Repair

The following instructions relevant to safe use in a hazardous area apply to equipment covered by CSA certificate numbers 80005457, IECEx CML 20.0054, CML 19ATEX2194 and CML 21UKEX2122.

1. The BTST v1.1 may be used in Division 1, 2 and Zones 0, 1, 2 hazardous areas that require IIC, IIB or IIA protection and temperature class T1, T2, T3 or T4.

2. The following checks must be conducted on the BTST v1.1 prior to taking it into a hazardous area:

a. The BTST v1.1 function must be checked by ensuring a red or green LED illuminates on the front of the Setting Tool when any button is pressed. If an LED does not illuminate, the BTST v1.1 requires inspection and battery replacement.

b. The BTST v1.1 does not require assembly or dismantling, however suitable precautions must be taken if the BTST v1.1 may come into contact with damaging substances (e.g. solvents that degrade polymeric materials). Regular inspections must be performed to confirm enclosure damage is not apparent. Do not use the equipment if damage is present.

3. The BTST v1.1 is not intended to be repaired by the user. Repair of the equipment is only permitted by the manufacturer or an approved agent in accordance with applicable code of practice.

4. No user adjustment of the BTST v1.1 is required.

5. The BTST must be inspected every three months, in a safe (non-hazardous), dry area by suitably trained personnel, to ensure it has been maintained in accordance with the applicable code of practice.

6. Subject to the applicable code of practice, the batteries may be replaced in a non-hazardous area with one of the following types of Alkaline-Manganese or Zinc-Manganese 'AAA' size batteries:

- Duracell Procell type MN2400
- Energizer HighTech
- Duracell Ultra
- VARTA Industrial
- VARTA High Energy
- Panasonic Pro Power
- Eveready Super
- Duracell Chinese

7. The BTST v1.1 contains no other user-replaceable parts and it cannot be repaired by the user. If the BTST v1.1 is faulty or needs repairing, it must not be used.

**Refer to Publication PUB095-013 Rotork Actuator Setting Tool Pro v1.1 manual for full details and BTST user instructions.**

## 2. Health and Safety

This manual is produced to enable a competent user to install, operate, adjust and inspect Rotork IQT range valve actuators. Only persons competent by virtue of their training or experience should install, maintain and repair Rotork actuators.

In order to maintain the security of the actuator and any connected systems, it is recommended that operators / end users take appropriate measures to prevent access by unauthorised persons. This may include both measures to control or restrict physical access to the actuator, the selection of an appropriate security level within the actuator's settings and adopting a suitable actuator password prior to it being put into service. For instructions as to how to change the password and security level settings please refer to PUB002-040.

Under no circumstances should replacement parts be used in Rotork actuators, other than those supplied or specified by Rotork.

Work undertaken must be carried out in accordance with the instructions in this and any other relevant manuals.

If the actuator is used in a manner not specified in this manual and any other Rotork manual, the protection provided by the actuator may be impaired.

The user and those persons working on this equipment should be familiar with their responsibilities under any statutory provisions relating to the Health and Safety of their workplace. Due consideration of additional hazards should be taken when using the IQT range of actuators with other equipment. Should further information and guidance relating to the safe use of the Rotork IQT range of actuators be required, it will be provided on request.

The electrical installation, maintenance and use of these actuators should be carried out in accordance with the National Legislation and Statutory Provisions relating to the safe use of this equipment, applicable to the site of installation.

**For the USA:** NFPA70, National Electrical Code® is applicable.

**For Canada:** CEC, Canadian Electrical Code is applicable.

The mechanical installation should be carried out as outlined in this manual and also in accordance with relevant standards such as British Standard Codes of Practice. If the actuator has nameplates indicating that it is suitable for installation in hazardous areas then the actuator may be installed in Zone 1, Zone 21, Zone 2 and Zone 22 (Class I Division 1, Class II Division 1) classified hazardous area locations only. It should not be installed in hazardous area locations with an ignition temperature less than 135 °C, unless suitability for lower ignition temperatures has been indicated on the actuator nameplate.

It should only be installed in hazardous area locations compatible with the gas and dust groups stated on the nameplate.

The electrical installation, maintenance and the use of the actuator should be carried out in accordance with the code of practice relevant for that particular Hazardous Area certification.

No inspection or repair should be undertaken unless it conforms to the specific hazardous area certification requirements. Under no circumstances should any modification or alteration be carried out on the actuator, as this could invalidate the actuator's hazardous area approval certification.



Access to live electrical conductors is forbidden in the hazardous area unless this is done under a special permit to work, otherwise all power should be isolated and the actuator moved to a non-hazardous area for repair or attention.

**⚠ WARNING: Service Altitude**

Actuator installation is permitted up to 5,000 m with the following restriction:

- Input and output connections must use the 24 VDC nominal supply

Installation without restrictions must be less than 2,000 m as defined by IEC61010-1 (Safety requirements for electrical equipment for measurement, control and laboratory use).

**⚠ WARNING: Motor Temperature**

Under normal operation the temperature of the actuator's motor cover surfaces can exceed 60 °C above ambient.

**⚠ WARNING: Surface Temperature**

The installer/user must ensure that the actuator surface temperature rating is not influenced by external heating/cooling effect (e.g. valve/pipeline process temperatures).

**⚠ WARNING: Thermostat Bypass**

If the actuator is configured to bypass the motor thermostat then the hazardous area certification will be invalidated. Additional electrical hazards may occur when using this configuration. The user should ensure that any necessary additional safety measures are considered.

**⚠ WARNING: Enclosure Materials**

IQT range of actuators are manufactured from aluminium alloy with stainless steel fasteners and the non-thrust bases are manufactured in aluminium.

The cover window is toughened glass which is retained with a 2-part silicone cement and the battery plug for the 9V Battery will be either stainless steel or PPS (Poly-Phenylene Sulphide).

The wireless aerial is made from Polytetrafluoroethylene (PTFE).

The user must ensure that the operating environment and any materials surrounding the actuator cannot lead to a reduction in the safe use of, or the protection afforded by, the actuator. Where appropriate, the user must ensure the actuator is suitably protected against its operating environment.

**⚠ WARNING: Operating by Hand**

With respect to handwheel operation of Rotork electric actuators, refer to Section 4.1.

**⚠ WARNING: Unit Weight**

The actuator weight is shown on the nameplate. Care must be taken to transport, move or lift the actuator safely. Lifting information is available in Section 6.

**⚠ WARNING: Unexpected Operation**

When powered on, actuators can operate unexpectedly. Users must make provision for electrical isolation to prevent unintended operation and associated hazardous events. The actuator's STOP control knob (when fitted) is not an isolator and must not be considered as an emergency stop.

**⚠ WARNING: Mobile Devices**

Where applicable, users must ensure that any Windows, iOS or Android mobile devices must be suitably certified in accordance with the requirements of the standards and codes adopted by the national jurisdiction. The device must at least maintain the same level of Ex protection as the actuator.

## 2.1 ATEX, IECEx, UKEX and CSA Japan Certified Actuators

### Special Conditions

This actuator must only be located in areas where the risk of impact to the viewing window is low.

This equipment includes some exterior non-metallic parts including the protective coating. To avoid the possibility of static build up, cleaning must only be carried out with a damp cloth.

### **WARNING: External Enclosure Fasteners**

Enclosure fasteners are stainless steel grade A4-80 except for the following.

In these cases the fasteners are carbon steel grade 12.9. If in doubt check the grade marked on the relevant fastener or contact Rotork.

### All sizes of Actuator ATEX, IECEx & UKEX:

Ex db IIB T4 (T6) Gb (-20 to +70 °C)  
Electronics, Motor & Terminal enclosures

Ex db IIB T4 (T6) Gb (-30 to +70 °C)  
Electronics, Motor & Terminal enclosures

Ex db IIB T4 (T6) Gb (-40 to +70 °C)  
Electronics, Motor & Terminal enclosures

Ex db IIB T4 (T6) Gb (-50 to +40 °C)  
Electronics, Motor & Terminal enclosures

Certificate no.: CML 19ATEX1192X, IECEx CML20.0052X or CML 21UKEX1120X.

Ex db IIC T4 (T6) Gb (-50 to +40 °C)  
Terminal enclosure

Certificate no.: CML 19ATEX1193X, IECEx CML 20.0053X or CML 21UKEX1121X.

### FM / CSAus Approved:

Explosionproof, Class I, Div 1, Groups C, D (-50 to +40 °C) Electronics, Motor & Terminal enclosures

Explosionproof, Class I, Div 1, Groups B, C, D (-20 to +70 °C) Electronics & Motor enclosures

Explosionproof, Class I, Div 1, Groups B, C, D (-30 to +70 °C) Electronics & Motor enclosures

Explosionproof, Class I, Div 1, Groups B, C, D (-40 to +70 °C) Electronics & Motor enclosures

Explosionproof, Class I, Div 1, Groups B, C, D (-50 to +40 °C) Electronics & Motor enclosures

### CSA Approved:

Explosionproof, Class I, Div 1, Groups C, D (-50 to +40 °C) Electronics, Motor & Terminal enclosures

Explosionproof, Class I, Div 1, Groups B, C, D (-20 to +70 °C) Electronics, Motor & Terminal enclosures

Explosionproof, Class I, Div 1, Groups B, C, D (-30 to +70 °C)  
Electronics, Motor & Terminal enclosures

Explosionproof, Class I, Div 1, Groups B, C, D (-40 to +70 °C)  
Electronics, Motor & Terminal enclosures

Explosionproof, Class I, Div 1, Groups B, C, D (-50 to +40 °C)  
Electronics, Motor & Terminal enclosures

For detailed approvals information and °F temperature ranges, see page 29.

## 2.2 Indian Ex Certified Actuators

### Special Conditions

Rotork has maintained a more stringent gap and larger flame path length than required by the standard. The user must refer to Rotork before carrying out any repairs to the equipment. The flame path dimensions specified in certification drawings must not be modified.

The fastening screws for cover with spigot joint shall be stainless steel socket head cap screws of property class A4-80 and yield stress 240 MPa.

User should follow instructions given on the equipment nameplate for selection of cable and cable gland.

End user should follow manufacturer's instructions for replacement of the battery.

### Bureau of Indian Standards (BIS)

For details of BIS certification please visit [www.bis.gov.in](http://www.bis.gov.in)

## 3. Storage

If the actuator cannot be installed immediately, store it in a dry place until it is ready to connect incoming cables.

If the actuator has to be installed but cannot be cabled it is recommended that the plastic transit cable entry plugs are replaced with metal plugs which are sealed with PTFE tape.

The Rotork double-sealed construction will preserve internal electrical components perfectly if left undisturbed.

It is not necessary to remove any electrical compartment covers in order to commission the IQT actuator.

Rotork cannot accept responsibility for deterioration caused on-site once the covers are removed.

Every Rotork actuator has been fully tested before leaving the factory to give years of trouble-free operation, providing it is correctly commissioned, installed and sealed.

## 4. Operating your IQT Actuator

### 4.1 Operating by Hand

#### **⚠ WARNING**

**With respect to handwheel operation of Rotork electric actuators, under no circumstances should any additional lever device such as a wheel-key or wrench be applied to the handwheel in order to develop more force when closing or opening the valve as this may cause damage to the valve and/or actuator or may cause the valve to become stuck in the seated/ backseated position.**

**Keep clear of the handwheel when engaging hand operation. Actuators driving valves via extension shafts may be subject to retained shaft torsion which can cause the handwheel to rotate when hand operation is engaged.**

⚠ To engage handwheel drive pull the Hand/Auto lever into "Hand" position and turn the handwheel to engage the clutch. The lever can now be released where it will return to its original position. The handwheel will remain engaged until the actuator is operated electrically when it will automatically disengage and return to motor drive.

If required for local lockout purposes the Hand/Auto lever can be locked in either position using a padlock with a 6.5 mm hasp.

Locking the lever in the "hand" position prevents electrical operation of the actuator moving the valve.

### 4.2 Operating Electrically

Check that power supply voltage agrees with that on the actuator nameplate. Switch on power supply. It is not necessary to check phase rotation.

⚠ **Do not operate the actuator electrically without first checking, using one of the Setting Options (see Section 1.3), that at least the Basic Settings have been made (refer to Section 8).**

#### **Selecting Local/Stop/Remote Operation**

The red control knob enables either Local or Remote control, lockable in each position using a padlock with a 6.5 mm hasp.

When the control knob is locked in the Local or Remote positions the Stop facility is still available. The control knob can also be locked in the Stop position to prevent electrical operation by Local or Remote control.



Fig. 4.2.1 IQT3 Pro Local Controls

#### **Local Control**

With the red control knob positioned at Local (anti-clockwise) the adjacent black knob can be turned to select Open or Close. For Stop, turn red knob clockwise.

#### **Remote Control**

Rotate the red control knob to the Remote position (clockwise), this allows remote control signals to operate the actuator. Local Stop can still be used by turning the red knob anti-clockwise.

### 4.3 Display – Local Indication

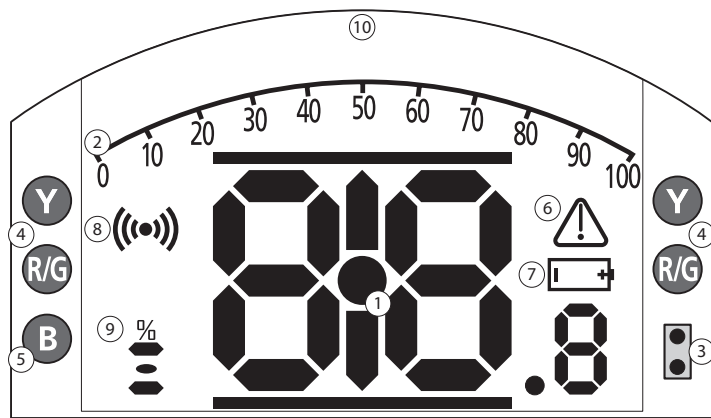

**LED INDICATION: R = RED, G = GREEN, Y = YELLOW, B = BLUE**

Fig. 4.3.1 Segment Display

#### 1. Position display

This is the main segment display for position and torque; position indication to 1 decimal place.

#### 2. Analogue Scale

Scale 0% to 100% is used when Analogue torque (% of rated) or Positioning (% position / demand) homescreens are selected. Refer to Section 4.4.

#### 3. Infrared LEDs

Used for older models of the Rotork Setting Tool and to initiate a data connection using Bluetooth wireless technology.

#### 4. Dual position LEDs

Consisting of 2 x Yellow for mid position and 2 x bi-colour (Red / Green) for end of travel indication.

#### 5. Bluetooth indication LED

A dual intensity LED for indicating an active connection using Bluetooth wireless technology.

#### 6. Alarm Icon

This will be displayed for valve, control and actuator alarms. Alarm indication is supported by fault description in the text in the line above the main display.

#### 7. Battery Alarm Icon

This icon will be displayed when a 9V Battery is detected as low or discharged. "Battery low" or "Discharged" will also be displayed in the text display above.

#### 8. Infrared Icon

This icon flashes during Setting Tool communication activity. LEDs will also flash when keys are pressed.

#### 9. Percentage Open Icon

This icon will be displayed when a percentage open value is displayed e.g. 57.3.

#### 10. Dot Matrix Display

A high resolution 168x132 pixel display for displaying setup menus and data logger graphs.

When a positional display is active, the status and active alarms will be displayed.

The LCD screen is made up of two layers; the main segment display and the dot matrix display. The displays are dual stacked so that either display can be enabled to show different information. This also allows a combination of both displays for added flexibility.

On power the LCD is backlit with a white light to enable the best viewing contrast in all lighting conditions. For additional positional indication, the LEDs at either side of the LCD are used for Closed (green), mid-travel (yellow) and Open (red) as standard. These LEDs are fully configurable in the settings menu or on request at time of order.

#### 4.4 Display – Home Screen Selection

The actuator display can be set to show any one of the following home screens:



- Position indication
- Position & Digital Torque indication
- Position & Analogue Torque indication
- Position & Control Demand indication

The default home screen is Position. Home screens indicate the live conditions measured by the actuator when mains power is applied. When mains power is switched off the 9V Battery powers the display and it will show the position indication display only.

The required home screens can be set by the user either as a permanent display or as a temporary display for valve or actuator operational analysis.

**⚠ NOTE: Before using the displays, please ensure that the actuator is set to Local Control or Stop.**

#### Temporary Home Screen display.

Using the Setting Tool (refer to Section 8.1)  or  arrow keys, scroll through the available home screens until the required one is displayed. The selected screen will remain displayed for approximately five minutes after the last Setting Tool command or until the actuator power is cycled. Manual setup can also be used to do this, as described in Section 8.2.

#### Permanent Home Screen display.

Connect to the actuator using one of the Setting Options in Section 1.3.

From the **Settings** menu, select **Indication > Local Display**. From the available settings, select **Home Screen**. Enter the password if requested (refer to Section 8.3), select Home Screen and from the dropdown list, select the required Home Screen for permanent display:

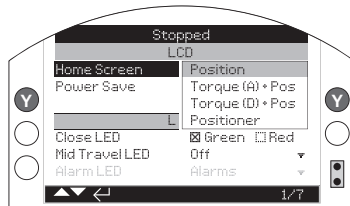

Fig. 4.4.1 Home Screen Selection

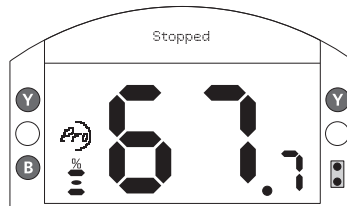

Fig. 4.4.2 Position

#### Position - Default valve position display

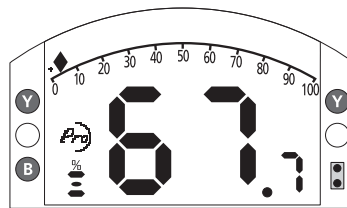

Fig. 4.4.3 Torque (A) + Position

#### Torque (A) + Pos - Position with analogue torque indication

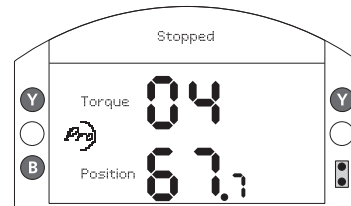

Fig. 4.4.4 Torque (D) + Position

#### Torque (D) + Pos - Position with digital torque indication

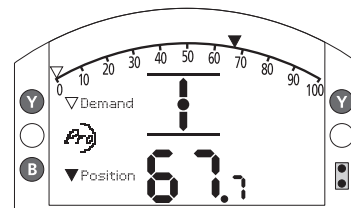

Fig. 4.4.5 Positioner

#### Positioner - Position with digital and analogue position demand indication

Once selected, the set display will be the active, permanent home screen.

#### 4.5 Display Status Indication – Travel

The IQT display provides real-time status indication. The top line of the text area is reserved for travel status indication.

Fig 4.5.1 shows the travel status example of **CLOSED LIMIT**

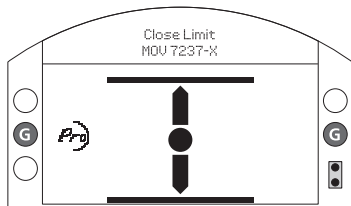

Fig. 4.5.1

#### 4.6 Display Status Indication – Control

The bottom line of the text area is reserved for control status indication and is displayed for approximately 2 seconds after the control mode or signal is applied.

Fig 4.6.1 shows the control status example **Remote Control**.

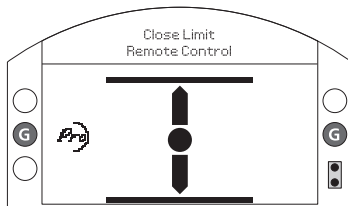

Fig. 4.6.1

#### 4.7 Display Alarm Indication

The IQT display provides alarm indication in the form of text and alarm icons.

There are 2 alarm icons:

General Alarm:



Battery Alarm:



The general alarm icon will be supported with text in the bottom line indicating the particular alarm, or if more than one is present, each alarm will be displayed in sequence.

Fig 4.7.1 shows the status example: **TORQUE TRIP CLOSED**

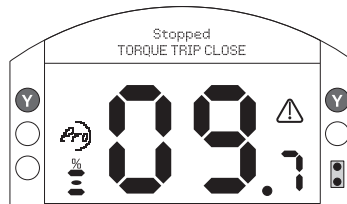

Fig. 4.7.1

#### 4.8 Battery Alarm

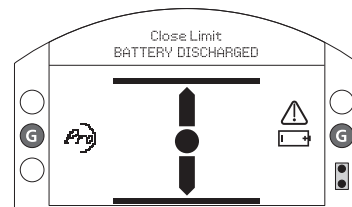

Fig. 4.8.1

The actuator checks the 9V Battery charge at approximately 1 hour intervals. The battery alarm icon is displayed when the actuator detects low charge and the display will indicate **BATTERY LOW**. If the battery is flat, or missing, the display will indicate **BATTERY DISCHARGED**.

When a low or discharged battery alarm is displayed the 9V Battery should be replaced immediately. It is essential that the correct battery type is fitted to maintain actuator certification. Refer to Section 9 for details.

**After replacing a battery, the alarm icon will continue to be displayed until the next check and may take up to 1 hour. Cycling the power will force a battery check and clear the alarm.**

## 5. Preparing the Drive Bush

### 5.1 Bases F05 to F07 and FA05 to FA07

The base adaptor must be removed to give access to the drive bush. Remove the four capscrews and base adaptor as shown in Fig 5.1.1.

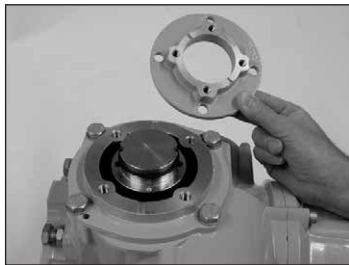

Fig. 5.1.1

Clear access to the drive bush is now available as shown in Fig 5.1.1. Using the a 3 mm allen key, unscrew the two capscrews retaining the drive bush and remove the drive bush from the actuator.

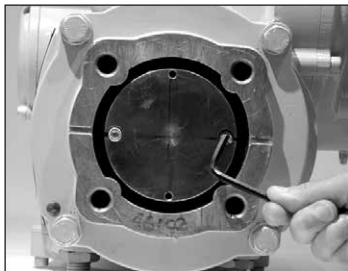

Fig. 5.1.2

### 5.2 Bases F10 to F16 and FA10 to FA16

Removal of the drive bush does not require the removal of the actuator base. Using a 3 mm allen key, unscrew the two capscrews retaining the drive bush.

Capscrews can be used to remove the drive bush by screwing into the drive bush as shown in Fig 5.2.1.

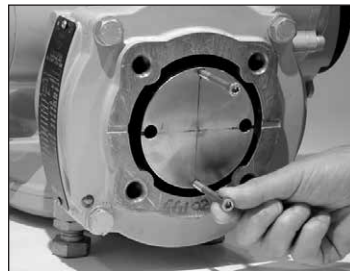

Fig. 5.2.1

The range of IQT drive bushes is shown in Fig 5.2.2. Please refer to PUB002-038 for maximum stem acceptance details.



Fig. 5.2.2

### 5.3 Machining the Drive Bush

Once removed, the drive bush can be machined to suit the valve stem. Ensure machined position allows correct orientation of actuator-to valve flange and correct direction to close the valve.

### 5.4 Fitting the Drive Bush

Note: The drive bush can be fitted in four possible positions, 90° apart. Fit the drive bush into the centre column ensuring that the stem orientation, actuator position and direction of operation are correct for valve operation. Secure the drive bush with the capscrews. For F05, FA05, F07 and FA07 bases, refit the base adaptor and secure with the four capscrews.

## 6. Mounting the Actuator

**⚠ Refer to Section 11 Weights and Measures for actuator weight.**

### 6.1 IQT Actuators

The IQT range of actuators are suitable for part turn applications requiring up to 60 starts per hour.

### 6.2 IQTM Actuators

The IQTM range of actuators are suitable for modulating control duty of up to 1,800 starts per hour in accordance with IEC 60034-1 to S4 50%. Commissioning of IQTM range actuators is identical to the standard IQT (refer to Sections 8, 9 and 10).

### 6.3 IQTF Actuators

The IQTF range of actuators are suitable for part-turn and multi-turn, non-thrust applications requiring low speed and low operating turns. Commissioning of IQTF range actuators is similar to the standard IQT (refer to Sections 8, 9 and 10).

IQTF L actuators include a lead screw type linear drive assembly attached to the base of the IQTF actuator. This provides linear output stroke between 8 mm (1/4 in) and 153 mm (6 in) depending on size and speed.

The linear drive unit is lubricated from the factory with extreme pressure multi-purpose FUCHS RENOLIT CL X2 grease to suit all operating temperature ranges.

A grease nipple is situated in the base of the actuator to enable lubrication of the lead screw.

Apply two pumps of the specified grease from a standard grease gun every 30,000 starts. More frequent greasing may be necessary depending on usage and temperature.

### 6.4 Lifting the Actuator

Ensure the valve is secure before fitting the actuator, as the combination may be top heavy and therefore unstable.

When lifting the actuator using mechanical lifting equipment certified slings should be attached as indicated in Fig 6.4.1. At all times trained and experienced personnel should ensure safe lifting, particularly when mounting actuators.

**⚠ WARNING: Do not lift the actuator by the handwheel.**

A suitable mounting flange conforming to ISO 5210 or USA Standard MSS SP101 must be fitted to the valve. Actuator to valve fixing must conform to; Material Specification ISO Class 8.8, yield strength 628 N/sq mm.

**⚠ WARNING: Do not lift the actuator and valve combination via the actuator. Always lift the valve/ actuator assembly via the valve.**

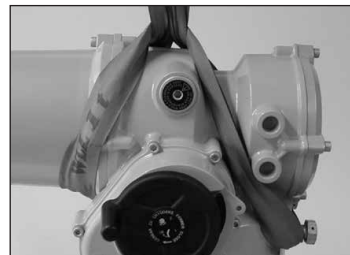

Fig. 6.4.1

**⚠ WARNING: The actuator should be fully supported until full valve stem engagement is achieved and the actuator is secured to the valve flange.**



Fig. 6.4.2



## 6.5 Securing Actuator to Valve

Before engagement ensure that the actuator and valve are in the same position (i.e. closed) and the drive bush-machining matches the stem position. Actuator position can be determined using the display (refer to Section 4.4) and if necessary can be moved using the handwheel (refer to Section 4.1). It may be necessary to adjust the stop bolts to enable sufficient travel. Refer to Section 6.6.

Tighten down onto valve flange to the required torque, see Table B.

Metric		Torque	
Flange	Fixing	Nm	lbf.ft
F05	M6	5.4	4
F07	M8	12.8	9.4
F10	M10	51.6	38
F14	M16	219.8	162.1
F16	M20	430.5	317.5
Imperial		Torque	
Flange	Fixing	Nm	lbf.ft
FA05	1/4	6.7	4.9
FA07	5/16	12.6	9.3
FA10	3/8	42.3	31.2
FA14	5/8	205.3	151.4
FA16	3/4	363.6	268.1

Table B

Secure actuator to valve with four fixing bolts. Check that the cast groove in actuator base is not obstructed see Fig 6.4.2. Its purpose is to protect the actuator in the event of a product leak from the valve stem/gland packing. Check base fixing bolts are tight.

## 6.6 Stop Bolts

It is recommended that stop bolt adjustment be carried out by the valvemaker/supplier before the valve is fitted into pipework. Once installed, the valve maker/supplier should be consulted before stop bolt readjustment is carried out. Stop bolts can be wired to prevent tampering. After setting or adjustment of stop bolts the actuator limits must be reset, refer to Sections 8.5 and 8.6.

The IQT stop bolts are located below the terminal compartment. Stop bolt adjustment allows +/- 5° variation of travel at each end position. Screwing bolts in reduces movement, out increases movement. For clockwise closing valves the right hand bolt is the closed stop as shown with spanner in Fig 6.6.1. The left is the open stop.



Fig. 6.6.1

### Stop Bolt sizes

IQT 125 to 500: M12 bolt requiring 19 mm AF spanner.

IQT1000 to 3000: M20 bolt requiring 30 mm AF spanner.

### Adjustment for non seating valves types

For closed and open stop position adjustment:

Undo stop bolt lock-nut. Move actuator and valve to the required stopping position (it may be necessary to unscrew stop bolt to allow more travel). Screw stop bolt in until a stop is felt. Tighten stop bolt lock nut.

### Adjustment for seating valves types

For closed and open stop position adjustment:

Undo stop bolt lock-nut. Move actuator and valve to the required seating position of the valve (it may be necessary to unscrew stop bolt to allow more travel). Screw stop bolt in until a stop is felt and then back off by 3 turns. Tighten stop bolt lock-nut.

### Reset actuator limits

Refer to Sections 8.5 and 8.6.

## 7. Cable Connections

### 7.1 Terminal Block Layout

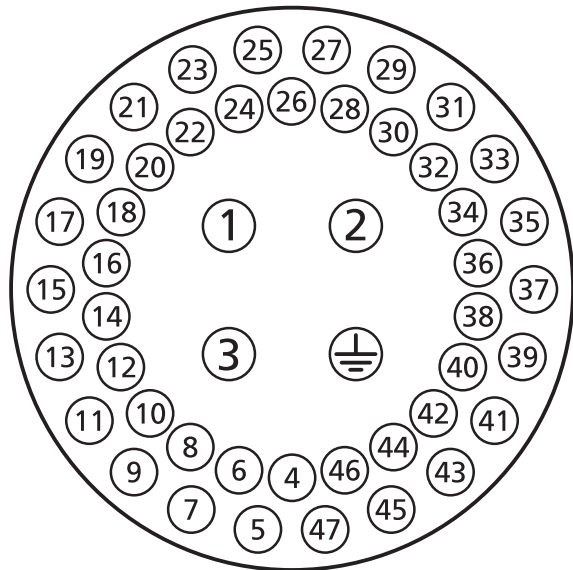

Fig. 7.1.1 Terminal numbers refer to connections as shown on the actuator circuit diagram

**⚠ WARNING: Ensure all power supplies are isolated before removing actuator covers.**

Check that the supply voltage agrees with that stamped on actuator nameplate.

A switch or circuit breaker must be included in the wiring installation or the actuator. The switch or circuit breaker must meet the relevant requirements of IEC60947-1 and IEC60947-3 and be suitable for the application. The switch or circuit breaker must not disconnect the protective earth conductor. The switch or circuit breaker must be mounted as close to the actuator as possible and shall be marked to indicate that it is the disconnect device for that particular actuator. The actuator must be protected with overcurrent protection devices rated in accordance with PUB002-068. The switch or circuit breaker shall disconnect both poles of a three phase supply.

**⚠ WARNING: Actuators for use on phase to phase voltages greater than 500 V must not be used on supply systems such as floating, or earth-phase systems, where phase to earth voltages, pertinent to mains supply system type and**

**nominal voltage, in excess of 500 VAC may exist; reference BS EN IEC 61010 - Annex I.**

### 7.2 Earth/Ground Connections

A lug with a 6 mm diameter hole is cast adjacent to the conduit entries for attachment of an external protective earthing strap by a nut and bolt. An internal earth terminal is also provided, however it must not be used alone as the Protective Earth connection.

### 7.3 Removing Terminal Cover

Using a 6 mm Allen key loosen the four captive screws evenly. Do not attempt to lever off the cover with a screwdriver as this will damage the O-ring seal and may damage the flamepath on a certified unit.

Actuators containing a Setting Tool fitted to the actuator are identified with a self-adhesive yellow label on the outside of the terminal compartment cover.

The wiring code card fixed in the cover is particular to each actuator and must not be interchanged with any other actuator. If in doubt check the serial number on the code card with that of the actuator.

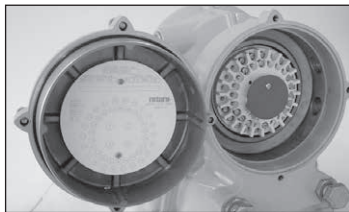

Fig. 7.3.1

A plastic bag in the terminal compartment contains: Terminal screws and washers, spare cover O-ring seal, wiring diagram and instruction book.

## 7.4 Cable Entry

Only appropriate certified explosionproof entry reducers, glands or conduit may be used in hazardous locations. In hazardous locations, only one appropriate certified explosionproof thread adaptor per entry may be used.

Remove red plastic transit plugs. Make cable entries appropriate to the cable type and size. Ensure that threaded adaptors, cable glands or conduit are tight and fully waterproof. Seal unused cable entries with a steel or brass threaded plug. In hazardous areas an appropriately certified threaded blanking plug must be used without the use of an interposing thread adaptor.

The cable entries on the actuator terminal housing are tapped M25 x 1.5p.

For installation in USA and Canada: Conduit seals must be installed at the enclosure. M25 x 1.5p to either 1/2", 3/4", 1", 1.25" or 1.5" NPT thread adaptors are factory fitted.

## 7.5 Connecting to Terminals

Refer to the wiring diagram inside the terminal cover to identify functions of terminals. Check that supply voltage is the same as that marked on the actuator nameplate.

Remove power terminal screen.

Begin by connecting these cables and replace screen. When all connections are made ensure wiring diagram is replaced in the terminal compartment.

**⚠ To ensure secure electrical connections, it is important that the requisite washers are used as shown in Fig 7.5.1. Failure to do so may result in connections working loose or screws not clamping down on ring crimp terminals. Spring washers must be compressed. Screw tightening torques must not exceed 1.5 Nm (1.1 lbf.ft).**

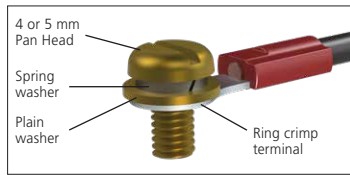

Fig. 7.5.1

**⚠ To comply with ex eb certification: Terminals numbered 1-3 and earth must be fitted with 1 off M5 insulated type ring tag suitable for 10 or 14 AWG conductors, Terminals numbered 4-47 must be fitted with 1 off M4 insulated type ring tag suitable for 14 or 16 AWG conductors. Only one conductor per ring tag is permitted.**

**⚠ WARNING: Wiring can reach 80 °C in a 70 °C ambient temperature. For safety reasons the same voltage level must be connected to all the actuator's indication terminals, remote input terminals and digital I/O terminals (if applicable).**

All external circuits must be provided with insulation suitable for the rated voltage whilst considering national regulations and statutory provisions.

## 7.6 Replacing Terminal Cover

Ensure cover O-ring seal and spigot joint are in good condition and lightly greased before re-fitting cover. Please refer to Figure 7.3.1 when replacing the cover. Use a torque wrench and 6 mm Allen key to tighten the bolts evenly to a torque of 16 Nm (12 lbf.ft).

ATTENTION: RED PLASTIC PLUGS IN CONDUIT ENTRIES ARE FOR TRANSIT ONLY. FOR LONG TERM PROTECTION FIT SUITABLE METAL PLUGS.

ATTENZIONE: I TAPPI IN PLASTICA ROSSA PER L'ENTRATA CAVI SONO SOLO TEMPORANEI. PER UNA PROTEZIONE PERMANENTE PREGO SOSTITUIRLI CON APPOSITI TAPPI METALLICI.

ATENCIÓN: LOS TAPONES ROJOS DE PLASTICO EN LAS ENTRADAS DE CABLE SON ÚNICAMENTE PARA TRANSPORTE. PARA PROTECCIÓN PERMANENTE COLOCAR TAPONES METÁLICOS APROPIADOS.

ACHTUNG: DIE ROTEN PLASTIKSTOPFEN SIND NUR FÜR DEN TRANSPORT GEEIGNET. FÜR DAUERHAFTEN SCHUTZ SIND DIESE GEGEN GEEIGNETE BLINDSTOPFEN AUSZUTAUŠCHEN.

ATTENTION: LES BOUCHONS PLASTIQUES ASSURENT UNE PROTECTION TEMPORAIRE. POUR UNE PROTECTION DEFINITIVE UTILISER DES BOUCHONS METALLIQUES.

注意: コンジット口の赤色プラグは、輸送用を目的としたプラグです。長期に渡る保護の場合、適切なメタルプラグをご使用ください。

注意: 接線端红色塑料封口仅为运输途中使用。长期正常保护时请用金属封口。

주의: 배선인입구의 빨간색 플라스틱 플러그는 오직 임시용입니다. 오래 보관하기 위해서는 규격에 맞는 금속 플러그를 사용하십시오.



## 8. Commissioning - Basic Settings

---

All actuator settings, data logger and asset management data is accessed using one of the Setting Options listed in Section 1.3. Status and alarm data in addition to that shown on the home screen can also be accessed.

**⚠ THE CONTROL COVER MUST NOT BE REMOVED; NO USER-CONFIGURABLE SETTINGS ARE AVAILABLE WITHIN THE CONTROL ENCLOSURE. THE CONTROL COVER IS SEALED BY A QUALITY LABEL WHICH IF BROKEN MAY INVALIDATE WARRANTY.**

This instruction details the basic settings that must be completed before the actuator is put into service.

**⚠ ELECTRICAL OPERATION MUST NOT TAKE PLACE UNTIL THE BASIC SETTINGS HAVE BEEN MADE AND CHECKED.**

The basic settings affect the correct operation of the valve by the actuator. If the actuator has been supplied with the valve, the valvemaker or supplier may have already made these settings.

**⚠ Settings and operation must be verified by electric operation and function test of the actuated valve.**

**THIS PUBLICATION PROVIDES INSTRUCTION ON MAKING THE BASIC SETTINGS ONLY.**

For instruction on control and indication settings and for information on diagnostics refer to PUB002-040.

## 8.1 Connecting to the Actuator Using Rotork Setting Tool

The Rotork Setting Tool incorporating Bluetooth wireless technology (Rotork Bluetooth® Setting Tool Pro v1.1 – BTST) is shown below. It is identified by the key symbols being clear and a clear seal between the top and bottom casings. The BTST has been produced with blue and black cases, with both having the same functionality.

The older infrared-only Rotork Setting Tool has a blue case with solid yellow keys and a yellow seal between casings.

Any of the above Setting Tools can be used with IQT3 or IQT3 Pro actuators.



Below are the relevant navigation and configuration keys to commission an IQ range actuator.

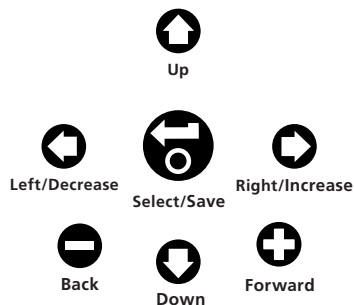

The actuator should be in LOCAL CONTROL or STOP before using the BTST.

Press the **Back** key repeatedly to return to the home screen.

### Connecting to the actuator using Bluetooth wireless

The default security set in the actuator for Bluetooth wireless connection is by initiation using an infrared command. This means that the user must be in close proximity and in direct line of sight of the actuator.

Point the Setting Tool at the actuator display window within a range 0.25 m (10 in) and Press **Down** key.

The screen will change to the Main Menu screen:

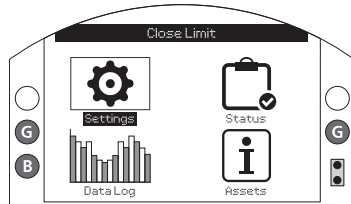

Fig. 8.1.1

**The Setting Tool will automatically connect using Bluetooth wireless which takes up to 5 seconds and when connected will be indicated by blue lights illuminating on the tool and in the actuator display window. Once connected, the tool can be used without pointing it at the actuator display window.**

Bluetooth wireless connection will be maintained while Setting Tool key commands are made. After a period of 6 minutes with no key commands, Bluetooth wireless connection will be turned off and the Setting Tool and display blue lights will go out. To manually turn off Bluetooth wireless connection at any time, press the Setting Tool **Back** and **Forward** keys together.

## 8.2 Connecting to the Actuator Using Manual Setup

This section describes how to use the manual setup feature introduced in Section 1.3.

### 8.2.1 Navigation and Commands

When using manual setup, the menus and commands displayed on the screen are navigated by using the OPEN/CLOSE control knob.

To navigate the screen, move the knob  $\frac{1}{8}$  turn clockwise or anti-clockwise, aligning one white dot with the notch on the casting. Hold the knob in this position for between 0.25 and 3 seconds.

To select a menu option, turn the knob fully ( $\frac{1}{4}$  of a turn) **clockwise**. Hold this position for 1 second. Release the knob to select the option.

To move backwards through a menu, turn the knob fully **anti-clockwise** ( $\frac{1}{4}$  of a turn) and hold for 1 second. On releasing the knob, the menu will go back one step.

To exit the Settings menu, repeatedly turn the knob anti-clockwise until you return to the home screen.

### 8.2.2 Manual Setup

**NOTE:** Manual setup is disabled by default. To enable this feature, follow the instructions below.

Place the LOCAL/STOP/REMOTE control knob into STOP or REMOTE before proceeding.

#### Step 1 – Activation

Using the BTST, navigate to **Settings > Indication > Local Display**

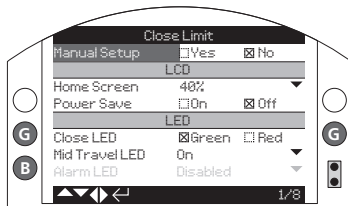

Fig. 8.2.3

Select **Manual Setup** and press the **OK** key.

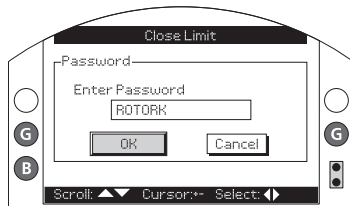

Fig. 8.2.4

Enter the actuator password and select **OK**.

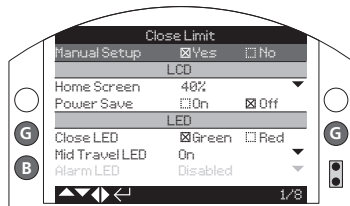

Fig. 8.2.5

Press the **Left** or **Right** key on the setting tool and select **Yes**. Press **OK** to confirm.

Once you have enabled the manual setup, initiation of app connection is no longer available through the method in Section 1.4.1. Please refer to Section 1.3 for other methods available for connection.

The Rotork app and manual setup can also be enabled/disabled separately.

#### Step 2 – Initiation

To initiate manual setup turn the OPEN/CLOSE control knob in the following sequence:

**clockwise > anti-clockwise > clockwise > anti-clockwise**

#### Step 3 – Exit Settings Menu

To exit the Settings menu:

1. Repeatedly turn control knob **anti-clockwise**, until the Home Screen is reached.
2. Set the LOCAL/REMOTE/STOP control knob to LOCAL.

Alternatively, the system automatically exits from manual setup if no commands are issued for 5 minutes.

### 8.3 Security – Password

**⚠ NOTE: In this and subsequent sections the symbols shown correspond to the BTST keys. See Section 1 for the equivalent commands on the Rotork app and manual setup.**

In order to maintain the security of the actuator and any connected systems, it is recommended that operators / end users take appropriate measures to prevent access by unauthorised persons. This may include both measures to control or restrict physical access to the actuator, the selection of an appropriate security level within the actuator's settings and adopting a suitable actuator password prior to it being put into service. For instructions as to how to change the password and security level settings please refer to PUB002-040.

The default security level for connecting to the actuator is by Bluetooth wireless initiation. Infrared connection requires that the user is at the actuator within 0.25 metre distance and in direct line of sight of the display. For instruction on connecting to the actuator refer to Section 8.1.

All actuator settings can be viewed with the actuator selected to LOCAL, STOP or REMOTE mode.

**To change an actuator setting, the actuator must be selected to LOCAL or STOP and a correct password entered.**

If the actuator is selected to REMOTE and a setting is selected, the following warning will be displayed:

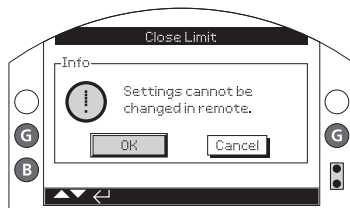

Fig. 8.3.1

Select **OK** to return to settings screen.

With the actuator selected to LOCAL or STOP and when any function is selected, the Password screen will be displayed:

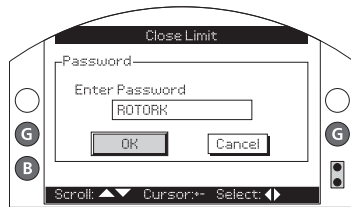

Fig. 8.3.2

**The factory set default password ROTORK is displayed and the OK key is highlighted.**

Press the **⏎** key.

The setting screen will again be displayed. The example below shows **Settings > Limits > Close Settings** with the function **Action** highlighted:

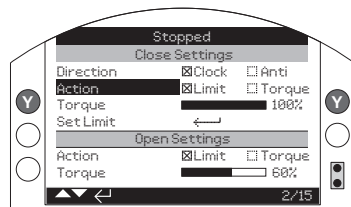

Fig. 8.3.3

Press the **⏎** key to select.

The function and its setting option or range will then be highlighted:

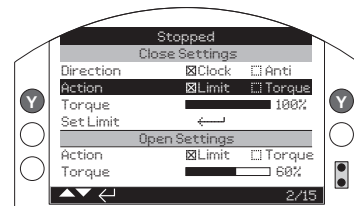

Fig. 8.3.4

**If the user does not wish to change the function value, press the back button to escape without changing.**

Use the ◀ or ▶ arrow keys to change the setting to the required value, the example below show a close action of **Torque** having been selected.

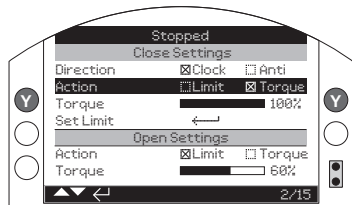

Fig. 8.3.5

Press the  key to select.

The highlight will return to the function name only and its stored setting will be displayed:

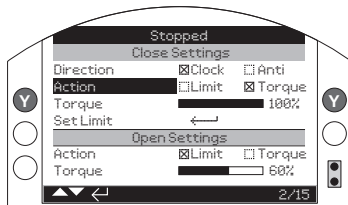
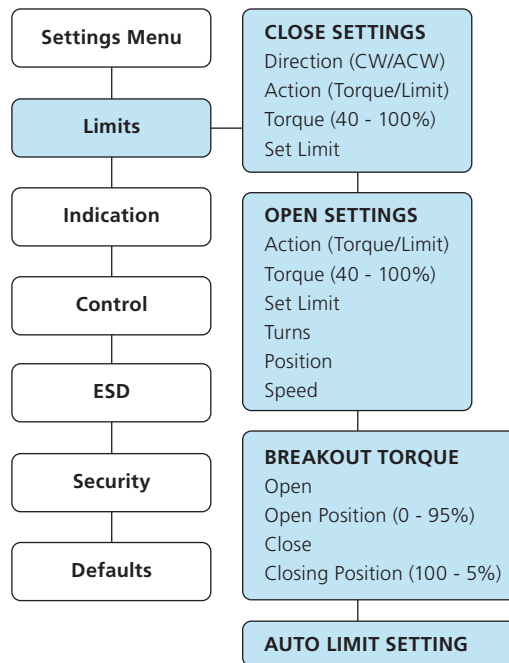

Fig. 8.3.6

The password will be requested the first time a function is selected. Once correctly entered, the password will not be required to be entered again for the duration of setting tool communication with the actuator. Other functions can be set as required.

## 8.4 Basic Settings Menu





## 8.5 Basic Settings – Limits

⚠ **Settings and operation must be verified by electric operation and function test of the actuated valve.**

Connect to the actuator as described in Section 8.1. From the Position display home screen press the **⏏** key. The main menu will be displayed.

Navigate to **Settings** using the **⏏** **⏏** keys and press **⏏** to select.

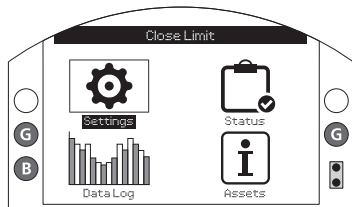

Fig. 8.5.1

The settings menu will be displayed:

Settings	
Limits	
Indication	
Control	
ESD	
Security	
Defaults	

Navigate to **Limits** using the **⏏** **⏏** keys and press **⏏** to select.

**The setting first selected to be changed will require a password to be entered – refer to Section 8.3.**

The limit settings are shown below with their factory default values:



Limits	
Close Settings	
1 / 16	Direction <input checked="" type="checkbox"/> Clock <input type="checkbox"/> Anti
2 / 16	Action <input checked="" type="checkbox"/> Limit <input type="checkbox"/> Torque
3 / 16	Torque <input type="text" value="40%"/>
4 / 16	Set Limit <input type="text" value="←"/>
5 / 16	Speed Close <input type="text" value="40%"/>
Open Settings	
6 / 16	Action <input checked="" type="checkbox"/> Limit <input type="checkbox"/> Torque
7 / 16	Torque <input type="text" value="40%"/>
8 / 16	Set Limit <input type="text" value="←"/>
9 / 16	Turns <input type="text" value="0.2"/>
10 / 16	Position <input type="text" value="95.0"/>
11 / 16	Speed Open <input type="text" value="100%"/>
Breakout Torque	
12 / 16	Opening <input type="checkbox"/> On X <input checked="" type="checkbox"/> Off
13 / 16	OP Position <input type="text" value="10%"/>
14 / 16	Closing <input type="checkbox"/> On X <input checked="" type="checkbox"/> Off
15 / 16	CL Position <input type="text" value="90%"/>
Auto Limit Setting	
16 / 16	Auto Set Limit <input type="text" value="←"/>
<input type="text" value="▲"/> <input type="text" value="▼"/> <input type="text" value="←"/> 1 / 16	

Function Close Direction (1 / 16) is shown highlighted. Use **⏏** **⏏** to scroll through functions. Functions will be highlighted in turn. NOTE: Independent speeds for Open and Close are only available with UIB firmware version V205 or later.

## 8.6 Close Settings

### 1 / 16. Close Direction

Function sets the direction required to close the valve. Manually operate the actuator and valve to establish closing direction.

Press  to select Close Direction function. Use  or  to check required setting. Press  to set.

### 2 / 16. Close Action

The actuator can be configured close on torque for seating valve types or limit for non-seating valve types.

 **Refer to valve manufacturer for recommended setting. In the absence of valvemaker instruction refer to the following table.**

Valve Type	Close Action	Open Action
Butterfly (metal seat: triple offset)	Torque	Limit
Butterfly (metal seat: other)	Limit	Limit
Butterfly (resilient seat)	Torque	Limit
Ball	Limit	Limit
Plug	Limit	Limit
Choke (IQTF)	Limit	Limit
Globe (IQTF)	Torque	Limit
Parallel Slide	Torque	Torque

Press  to select Close Action function. Use  or  to check required setting. Press  to set.

**Note: IQT3 Pro includes mechanical stops; refer to section 6.6 for information on their adjustment. Consult the valve manufacturer for confirmation of Close/Open action settings and mechanical stop adjustment.**

IQTF actuators do not have mechanical stops but the number of output turns is limited (see 8/16 Set Open Limit).

IQTF-L linear output actuators are limited to a maximum stroke of 153 mm or 22 turns of the linear thread lead, whichever is shorter.

### 3 / 16. Close Torque

The value of torque available to close the valve can be set between 40% and 100% of rated. The actuator rated torque value is shown on its nameplate.

Press  to select Close Torque function. Use  key to decrease value and  key to increase value.

Press  key to set.

### 4 / 16. Set Close Limit

Press  to select Close Limit Function. The actuator will display the following instruction:

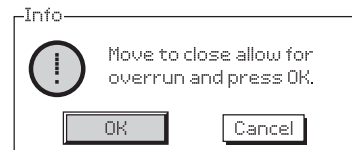

Fig. 8.6.1

Move the actuator and valve to the close position. Allow for overrun by winding in the opening direction by ½ to 1 turn of the handwheel.

Press  to set the close limit position.

### 5 / 16. Speed Close

This is the percentage of maximum speed used to perform a close operation.

Press  to select Speed Close function. Use  key to decrease value and  key to increase value.

Press  key to set.

## 8.7 Open Settings

### 6 / 16. Open Action

The actuator can be configured open on torque for seating valve types or limit for non-seating valve types.

**⚠ Refer to Valve manufacturer for recommended setting. In the absence of valvemaking instruction set open action to "Limit".**

Press **⏸** to select Open Action function. Use **⬅** or **➡** to check required setting. Press **⏸** to set.

### 7 / 16. Open Torque

The value of torque available to open the valve can be set between 40% and 100% of rated. The actuator rated torque value is shown on its nameplate.

Press **⏸** to select Open Torque function. Use **⬅** key to decrease value and **➡** key to increase value.

Press **⏸** to set.

### 8 / 16. Set Open Limit

Press **⏸** to select Open Limit Function. The actuator will display the following instruction:

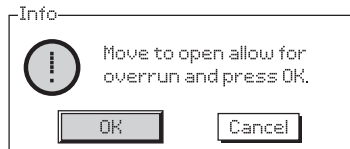

Fig. 8.7.1

Move the actuator and valve to the open position. Allow for overrun by winding in the closing direction by ½ to 1 turn of the handwheel.

Press **⏸** to set the open limit position.

### 9 / 16. Turns (not editable)

Shows the actuator output turns between the set Closed and Open limit positions.

**⚠ Note: IQTF is limited to a maximum of 22 turns.**

### 10 / 16. Position (not editable)

Shows the actuator current position in terms of % open.

**Note: Turns and Position values do not update while being displayed on screen. To see updated values, use **⏸** key to return to Settings Menu, then select Limits.**

### 11 / 16. Speed Open

This is the percentage of maximum speed used to perform an open operation.

Press **⏸** to select Speed Open function. Use **⬅** key to decrease value and **➡** key to increase value.

Press **⏸** key to set.

## 8.8 Breakout Torque

The default setting for opening and closing breakout torque is Off (torque protection active at all times). Bypassing the torque protection allows torque up to approximately 150% of rated to be available. The valvemaking / integrator should be consulted to confirm the valve structure and interface components can withstand the additional torque/thrust.

### 12 / 16. Opening

Opening torque protection can be bypassed over a configurable portion of the opening stroke. When enabled, torque up to approximately 150% of rated torque is available for opening "sticky" valves.

Press **⏸** to select Opening Breakout Torque function. Use **⬅** or **➡** to check required setting.

Press **⏸** to set. You will be presented with a warning screen that informs you that setting opening breakout torque removes torque protection. You need to select OK or CANCEL.

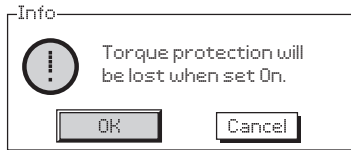

Fig. 8.8.1

### 13 / 16. OP Position

When enabled (refer to 12 / 16), the position over the opening stroke where the torque protection is bypassed can be configured in the position range 0% (closed limit) to 95% open. Outside the bypass position, torque limit value will revert to that set, refer to 7 / 16.

Press to select Opening Bypass Position function. Use key to decrease value and key to increase value. Press to set.

### 14 / 16. Closing

Closing torque protection can be bypasses over a configurable portion of the closing stroke. When enabled, torque up to approximately 150% of rated torque is available for closing the valve. Outside the bypass position, torque switch value will revert to that set, refer to 3 / 16.

Press to select Closing Breakout Torque function. Use or to check required setting.

Press to set. You will be presented with a warning screen that informs you that setting closing breakout torque removes torque protection. You need to select OK or CANCEL.

### 15 / 16. CL Position

When enabled (refer to 14 / 16), the position over the Closing stroke where the torque protection is bypassed can be configured in the position range 100% (open limit) to 5% open.

Press to select Closing Bypass Position function. Use key to decrease value and key to increase value. Press to set.

### 16 / 16. Auto Set Limit

The IQT comes with the feature to automatically set the limits. In order to perform this, the valve must require less than 40% of rated torque throughout travel. Actuators that require more than 40% should be setup manually.

Once activated the actuator will attempt to find the Close limit first and then the Open limit. During this time the actuator will run without warning through its full travel. No limits will be set until the full cycle has been completed. If the actuator detects an obstruction (or torque increases past 40%) then a limit may be set incorrectly. If in doubt perform the limit setting manually.

Press to select Auto Limit Set function. The actuator will display the following instruction:

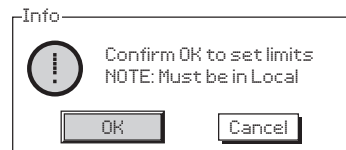

Fig. 8.8.2

Press to initiate the auto setup.

The actuator will attempt to run to the Close limit first, then run to the Open limit. Once both limits have been detected by a high mechanical resistance, the limits will be saved to memory.

If the sequence is interrupted or a fault detected during the setup, the following error will be displayed:



Fig. 8.8.3

## 9. Maintenance, Monitoring and Troubleshooting

### Maintenance

Every Rotork actuator has been fully tested before dispatch to give years of trouble-free operation providing it is installed, sealed and commissioned in accordance with the instructions given in this publication.

The IQT actuator's unique non-intrusive enclosure provides complete protection for the actuator components.

The IQT actuator gearing is located in an oil bath and is lubricated for life and does not need replenishing. Should the oil be removed or lost, the actuator must not be electrically operated, as premature failure may result.

Covers should not be removed for routine inspection as this may be detrimental to the future reliability of the actuator.

The electrical control module cover is bonded by the Rotork quality control seal. It should not be removed as the module contains no site-serviceable components.

All electrical power supplies to the actuator must be isolated before any maintenance or inspection is carried out, except replacement of the 9V Battery.

Electrical supplies must be isolated before actuator covers are removed – refer to battery replacement instructions.

Routine maintenance should include the following:

- Check actuator to valve fixing bolts for tightness
- Ensure valve stems and drive nuts are clean and properly lubricated
- If the motorised valve is rarely operated, a routine operating schedule should be set up
- Replace 9V Battery every 3 years
- Check the actuator enclosure for damage, loose or missing fasteners
- Ensure there is not an excessive build up of dust or contaminant on the actuator
- Check for any loss of lubricant. (refer to Section 11 for lubricants)

### 9V Battery

The 9V Battery compartment is accessible through the external battery plug on the actuator gearcase. The 9V Battery is the only replaceable battery and supports the actuator indication relays, data logger and the position display (LCD) only when the main power supply is turned off. It ensures the current position is indicated and displayed when manual operation takes place.

The battery is not required to retain any actuator settings or track position changes.

With mains power switched off and without a 9V Battery fitted or when discharged, all configured settings are retained safely in EEPROM and position changes are tracked by the absolute encoder.

On power up, the correct, current position will be displayed and the actuator will operate normally.

**⚠ WARNING: The 9V Battery holder in the actuator gearcase also protects the user from the hazardous live connections inside the actuator and therefore it must not be damaged. The actuator must be isolated or disconnected if the battery holder has to be removed from the actuator gearcase.**

**⚠ WARNING:**

### 9V Battery Replacement

**If the actuator is located within a hazardous area, permission must be obtained in the form of a "hot work permit" or other local regulation before removal and/or replacement of the battery.**

Battery replacement must be carried out with mains power isolated.

### 9V Battery Removal

The actuator must be selected to Stop using the red control knob – refer to Section 4.2. Access to the battery is via a labelled sealing plug situated on the main gearcase near the handwheel hub.

Remove the sealing plug using the appropriate Allen key, ensuring the O-ring seal remains on the plug. Disconnect the battery wiring loom from the battery terminals. Using the black pull strap, lift the battery out of the rubber sealing pocket.

### Shutdown Battery Pack

The Shutdown Battery Pack is an optional battery pack installed within the actuator electrical enclosure. The Shutdown Battery Pack drives the actuator during power loss or on command by the operator. This battery pack is not replaceable. Refer to Section 16 for more information.

**⚠ CAUTION: UNDER NO CIRCUMSTANCES SHALL THE ELECTRICAL COVER BE REMOVED. REMOVAL OF THIS COVER MAY CAUSE DAMAGE TO THE BATTERY PACK WHICH MAY LEAD TO FIRE OR EXPLOSION.**



Fig. 9.0.1

### 9V Battery Types

International, EU and UK hazardous area certified actuators, use a lithium manganese dioxide battery as stated in Fig 9.0.2 Battery Type Table.

For USA and Canada hazardous area certified actuators, use an Ultralife U9VL lithium manganese dioxide battery. Equivalent, UL recognised, batteries may be used.

For non-hazardous actuators, recommend a lithium manganese dioxide battery, however any equivalent 9V battery may be used.

If in doubt regarding the correct battery type, contact Rotork.

Enclosure Type	Battery Type	Detail
Standard Temp	Ultralife PP3 Types	U9VL or U9VL-J-P
Low/High Temp	Rotork Part Numbers:	95-462 or 95-614

Fig. 9.0.2 Battery Type Table

### Fitting Replacement 9V Battery

Fit the pull strap around the replacement battery and insert into the rubber sealing pocket. Reconnect the battery wiring loom to the battery terminals. Refit the battery sealing plug ensuring O-ring is in good condition and correctly fitted. Hand tighten the sealing plug to 8 Nm (6 lbf.ft) using the appropriate Allen key.

### Oil

Unless specially ordered for extreme climatic conditions, Rotork actuators are dispatched with gearcases filled with Dextron II oil which is suitable for ambient temperatures ranging from -30 to +70 °C (-22 to +160 °F).

IQT actuators do not require regular oil changes (refer to Section 11, Weights and Measures).

### Torque and Position Monitoring

The IQT range of actuators incorporate real time, instantaneous Torque & Position monitoring as standard. Torque & Position can be used to monitor valve performance during operation. The effect of process changes (differential pressure etc.) can be evaluated, tight spots in valve travel can be pinpointed as well as gauging the torque developed through stroke

in order to set appropriate open and closed torque limit settings.

**There are two home screen displays that indicate torque and position simultaneously. Refer to Section 4.4.**

### Analogue Torque and Position indication

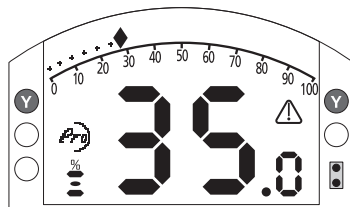

Fig. 9.0.3

Example shows that actuator at 35.0% open, producing 27% of rated torque. The warning triangle indicates the actuator has torque tripped.

Note: The torque and position values displayed are dynamic and will show the actual torque and position values currently measured. After a torque trip, the torque value tends to drop away as the internal mechanical components relax as no drive is present.

### Digital Torque and Position indication

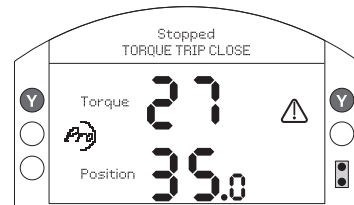

Fig. 9.0.4

Example shows that actuator at 35.0% open, producing 27% of rated torque. The status bar and warning triangle indicate that the actuator has torque tripped when closing.

Note: The actuator will torque trip and stop when the value of torque reaches that set for the open (when opening) and closing (when closing) torque switches (refer to Sections 8.5 and 8.6). Due to the effects of inertia (variable with speed/load) and valve resilience, the torque delivered and displayed may be higher.

## 10. Decommissioning and Environmental Considerations

End user advice on disposal at end of life of the product.

In all cases check local authority regulation before disposal.

The actuator can be removed by reversing the operations detailed in the mounting and cabling sections.

All warnings as detailed in the mounting and cable connection sections must be followed. Disposal of the actuator or any of its components should be done in accordance with the table below.

**⚠ WARNING: It is essential that the actuator is not subject to any valve / system loads at the time of removal as this could cause operator injury due to the actuator moving unexpectedly.**

Subject	Definition	Remarks / examples	Hazardous	Recyclable	EU Waste Code	Disposal
Batteries	Lithium	IQT 9V Battery	Yes	Yes	16 06 06	Will require special treatment before disposal, use specialist recyclers or waste disposal companies
	Lithium	IQT Shutdown Battery	Yes	Yes	16 06 05	
	Alkaline	Setting Tool	Yes	Yes	16 06 04	
Electrical & Electronic Equipment	Printed circuit boards	All products	Yes	Yes	20 01 35	Use specialist recyclers
	Wire	All products	Yes	Yes	17 04 10	
Glass	Lens / Window	IQT	No	Yes	16 01 20	Use specialist recyclers
Metals	Aluminium	Gearcases and covers	No	Yes	17 04 02	Use licensed recyclers
	Copper / Brass	Wire, IQT gears, motor windings	No	Yes	17 04 01	
	Zinc	IQT clutch ring and associated components	No	Yes	17 04 04	
	Iron / Steel	Gears and bases	No	Yes	17 04 05	
	Mixed metals	IQT motor rotors	No	Yes	17 04 07	
Plastics	Polycarbonate	IQT Shutdown Battery cover	No	No	20 01 39	Disposal as general commercial waste
	Glass filled nylon	Covers, electronics chassis	No	No	17 02 04	Use specialist recyclers
	Unfilled	Gears	No	Yes	17 02 03	
Oil /Grease	Mineral	Gearbox lubrication	Yes	Yes	13 02 04	Will require special treatment before disposal, use specialist recyclers or waste disposal companies
	Food grade	Gearbox lubrication	Yes	Yes	13 02 08	
	Grease	Side handwheel / linear drive	Yes	No	13 02 08	
Rubber	Seals & O-rings	Cover and shaft sealing	Yes	No	16 01 99	May require special treatment before disposal, use specialist waste disposal companies

## 11. Weights and Measures

### Lubricating oil

Refer to actuator name plate. IQT actuators are lubricated using the oil grades specified below. They are factory-filled for life and in normal service do not require topping up.

Ambient temperature ranges:

**Standard** -30 to 70 °C (-22 to 158 °F):

IQT Size 50-2000: FUCHS RENOLIN ZAF15LT lubricating oil.†

IQT Size 3000: FUCHS RENOLIN UNISYN OL 32 lubricating oil.†

**M61** -61 to 40 °C (-78 to 104 °F):

Size 50-500 only: HYDRAULIC OIL SHELL AEROSHELL FLUID 41.

### Food grade lubricating oil

If user-specified, IQT actuators will be filled with HYDRA LUBE GB LIGHT† lubricating oil suitable for temperature range -20 to 70 °C (-4 to 160 °F).

### Grease - Linear drive unit

IQTF L linear drive assemblies should be regularly lubricated using FUCHS RENOLIT CL X2. Refer to Section 6.3.

### Grease - Base assembly

O-rings use FUCHS CASSIDA GREASE CLEAR 2 FOOD or equivalent for all temperature ranges.

† **Oils and lubricants are subject to change due to supply availability at our worldwide manufacturing facilities. For detailed information please contact your local Rotork agent.**

Actuator Size	Weight kg (lbs)	Oil Capacities litres (pt.-US)
IQT 50, 100, 125, 250, 500	22 (48.5)	0.6 (1.3)
IQT 1000, 2000	37 (81.5)	1.6 (3.4)
IQT 3000	39 (86.0)	1.6 (3.4)

Refer to actuator nameplate for oil type. For oil plug location, refer to Section 1.1.

## 12. IQT Approvals

Refer to actuator nameplate for unit specific approval details.

### International – Hazardous Area

IECEx. IEC 60079-0, IEC 60079-1, IEC 60079-7, IEC 60079-31 & ISO 80079-36

Ex db<sup>1</sup> h IIB T4<sup>2</sup> Gb IP66/IP68

Ex h tb IIIC T120°C<sup>3</sup> Db

Temperature -20°C to +70°C (-4°F to +158°F)

\*Option -30°C to +70°C (-22°F to +158°F)

\*Option -40°C to +70°C (-40°F to +158°F)

\*Option -50°C to +40°C (-58°F to +104°F)

Ex db<sup>1</sup> h IIC T4<sup>2</sup> Gb IP66/IP68

Ex h tb IIIC T120°C<sup>3</sup> Db

Temperature -20°C to +70°C (-4°F to +158°F)

\*Option -30°C to +70°C (-22°F to +158°F)

\*Option -40°C to +70°C (-40°F to +158°F)

\*Option -50°C to +40°C (-58°F to +104°F)

<sup>1</sup> Ex eb added if the terminal enclosure is increased safety.

<sup>2</sup> Can be T6 when duty cycle is specified. Excludes intumescent coated actuators.

<sup>3</sup> Can be T80°C when duty cycle is specified. Excludes intumescent coated actuators.

**T6 and T80°C temperature classes rely on specific duty cycles refer to Section 15.**



## EU & UK – Hazardous Area

---

ATEX (2014/34/EU)

UKEX (2016 No. 1107)

II 2 G D

Ex db<sup>1</sup> h IIB T4<sup>2</sup> Gb IP66/IP68

Ex h tb IIIC T120°C<sup>3</sup> Db

Temperature -20°C to +70°C (-4°F to +158°F)

\*Option -30°C to +70°C (-22°F to +158°F)

\*Option -40°C to +70°C (-40°F to +158°F)

\*Option -50°C to +40°C (-58°F to +104°F)

Ex db<sup>1</sup> h IIC T4<sup>2</sup> Gb IP66/IP68

Ex h tb IIIC T120°C<sup>3</sup> Db

Temperature -20°C to +70°C (-4°F to +158°F)

\*Option -30°C to +70°C (-22°F to +158°F)

\*Option -40°C to +70°C (-40°F to +158°F)

\*Option -50°C to +40°C (-58°F to +104°F)

<sup>1</sup> Ex eb added if the terminal enclosure is increased safety.

<sup>2</sup> Can be T6 when duty cycle is specified. Excludes intumescent coated actuators.

<sup>3</sup> Can be T80°C when duty cycle is specified. Excludes intumescent coated actuators.

**T6 and T80°C temperature classes rely on specific duty cycles refer to Section 15.**

## USA – Hazardous Area

---

FM & CSAus Explosionproof to NEC Article 500.

FM 3600, FM 3615 & FM3616

Class I, Division 1, Groups C & D

Class II, Division 1, Groups E, F & G

Temperature -30°C to +70°C (-22°F to +158°F)

\*Option -40°C to +70°C (-40°F to +158°F)

\*Option -50°C to +40°C (-58°F to +104°F)

Class I, Division 1, Groups B, C & D

Class II, Division 1, Groups E, F & G

Temperature -30°C to +70°C (-22°F to +158°F)

\*Option -40°C to +70°C (-40°F to +158°F)

\*Option -50°C to +40°C (-58°F to +104°F)

## Brazil – Hazardous Area

---

INMETRO certification

Ex db IIB T4 Gb

Ex tb IIIC T120°C Db, IP66 & IP68

Temperature -20°C to +70°C (-4°F to +158°F)

\*Option -30°C to +70°C (-22°F to +158°F)

\*Option -40°C to +70°C (-40°F to +158°F)

\*Option -50°C to +70°C (-58°F to +158°F)

Ex db IIC T4 Gb

Ex tb IIIC T120°C Db, IP66 & IP68

Temperature -20°C to +70°C (-4°F to +158°F)

\*Option -30°C to +70°C (-22°F to +158°F)

\*Option -40°C to +70°C (-40°F to +158°F)

\*Option -50°C to +70°C (-58°F to +158°F)

Ex db eb IIB T4 Gb

Ex tb IIIC T120°C Db, IP66 & IP68

Temperature -20°C to +70°C (-4°F to +158°F)

\*Option -30°C to +70°C (-22°F to +158°F)

\*Option -40°C to +70°C (-40°F to +158°F)

\*Option -50°C to +70°C (-58°F to +158°F)

Ex db eb IIC T4 Gb

Ex tb IIIC T120°C Db, IP66 & IP68

Temperature -20°C to +70°C (-4°F to +158°F)

\*Option -30°C to +70°C (-22°F to +158°F)

\*Option -40°C to +70°C (-40°F to +158°F)

\*Option -50°C to +70°C (-58°F to +158°F)

## Canada – Hazardous Area

---

CSA Explosionproof to C22.2 No. 30

CSA Dust Ignition Proof to C22.2 No. 25

Class I, Division 1, Groups C & D

Class II, Division 1, Groups E, F & G

Temperature -30°C to +70°C (-22°F to +158°F)

\*Option -40°C to +70°C (-40°F to +158°F)

\*Option -50°C to +40°C (-58°F to +104°F)

Class I, Division 1, Groups B, C & D

Class II, Division 1, Groups E, F & G

Temperature -30°C to +70°C (-22°F to +158°F)

\*Option -40°C to +70°C (-40°F to +158°F)

\*Option -50°C to +40°C (-58°F to +104°F)

### China – Hazardous Area (CCC Ex)

2020322307001143 &  
2020322307001140

GB 3836.1 – 2021, GB 3836.2 – 2021  
GB 3836.3 – 2021, GB 3836.31 – 2021

**Ex db IIB T4 Gb**  
**Ex tb IIIC T120C Db IP66/IP68**

Temperature -20°C to +70°C (-4°F to +158°F)

\*Option -30°C to +70°C (-22°F to +158°F)

\*Option -40°C to +70°C (-40°F to +158°F)

\*Option -50°C to +40°C (-58°F to +104°F)

**Ex db IIC T4 Gb**  
**Ex tb IIIC T120C Db IP66/IP68**

Temperature -20°C to +70°C (-4°F to +158°F)

\*Option -30°C to +70°C (-22°F to +158°F)

\*Option -40°C to +70°C (-40°F to +158°F)

\*Option -50°C to +40°C (-58°F to +104°F)

**Ex dbeb IIB T4 Gb**  
**Ex tb IIIC T120C Db IP66/IP68**

Temperature -20°C to +70°C (-4°F to +158°F)

\*Option -30°C to +70°C (-22°F to +158°F)

\*Option -40°C to +70°C (-40°F to +158°F)

\*Option -50°C to +40°C (-58°F to +104°F)

**Ex dbeb IIC T4 Gb**  
**Ex tb IIIC T120C Db IP66/IP68**

Temperature -20°C to +70°C (-4°F to +158°F)

\*Option -30°C to +70°C (-22°F to +158°F)

\*Option -40°C to +70°C (-40°F to +158°F)

\*Option -50°C to +40°C (-58°F to +104°F)

### China – Hazardous Area (CCC Ex)

2020322307000647 &  
2020322307000648

GB 3836.1 – 2021, GB 3836.2 – 2021  
GB 3836.31 – 2021

**Ex db IIB T4 Gb**  
**Ex tb IIIC T120°C Db**

Temperature -20°C to +70°C (-4°F to +158°F)

\*Option -30°C to +70°C (-22°F to +158°F)

\*Option -40°C to +70°C (-40°F to +158°F)

\*Option -50°C to +40°C (-58°F to +104°F)

**Ex db IIC T4 Gb**  
**Ex tb IIIC T120°C Db**

Temperature -20°C to +70°C (-4°F to +158°F)

\*Option -30°C to +70°C (-22°F to +158°F)

\*Option -40°C to +70°C (-40°F to +158°F)

\*Option -50°C to +40°C (-58°F to +104°F)

### Indian – Hazardous Area

IS/IEC-60079-0, IS/IEC-60079-1

**Ex db IIB T4 Gb**

Temperature -20°C to +70°C (-4°F to +158°F)

**Ex db IIC T4 Gb**

Temperature -20°C to +70°C (-4°F to +158°F)

### Japan – National Standard – Explosion Proof Area

National Standard Explosionproof

JNIOOSH-TR-46-1(2015)

JNIOOSH-TR-46-2(2015)

**Ex d IIB T4 Gb**

**IP66 & IP68**

Temperature -20°C to +60°C (-4°F to +140°F)

Certificate Number: CSAUK 17JPN001X

**Ex d IIC T4 Gb**

**IP66 & IP68**

Temperature -20°C to +60°C (-4°F to +140°F)

Certificate Number: CSAUK 21JPN033X

労(令和2.1) 検	労(令和3.1) 検
CSAUK 17JPN001X	CSAUK 21JPN033X
ROTORK CONTROLS LTD	ROTORK CONTROLS LTD

## International – Non-Hazardous

### Ingress Protection, BS EN60529

IP66 & IP68, (7 metres for 72 hours).

Temperature -30°C to +70°C (-22°F to +158°F)

\*Option -40°C to +70°C (-40°F to +158°F)

\*Option -50°C to +40°C (-58°F to +104°F)

## USA – Non-Hazardous

### Enclosure Type 4X & 6

Temperature -30°C to +70°C (-22°F to +158°F)

\*Option -40°C to +70°C (-40°F to +158°F)

\*Option -50°C to +40°C (-58°F to +104°F)

## Canada – Non-Hazardous

### Enclosure Type 4, 4X & 6

Temperature -30°C to +70°C (-22°F to +158°F)

\*Option -40°C to +70°C (-40°F to +158°F)

\*Option -50°C to +40°C (-58°F to +104°F)

Rotork can supply actuators to national standards not listed above. For details please contact Rotork.

## 13. Approved Fuses

AC – FS1			
Transformer	Value	Manufacturer	Part number
Type 1	5.0A Anti-Surge	Schurter	8020.5018
		SIBA	70-065-65
Type 2	2.5A Anti-Surge	Schurter	8020.5015
		SIBA	70-065-65
Type 3	2.0A Anti-Surge	Schurter	8020.5014
		SIBA	70-065-65
Type 4	2.0A Anti-Surge	Schurter	8020.5014
		SIBA	70-065-65

AC – FS2			
Transformer	Value	Manufacturer	Part number
Types 1-4	20A ATO	Littlefuse	166.7000.5206

DC – FS1			
Transformer	Value	Manufacturer	Part number
Types 5	20A ATO	Littlefuse	166.7000.5206

DC – FS2			
Transformer	Value	Manufacturer	Part number
Types 5	500 mA	Bussmann	S505-500-R

FS3 – (Battery loom on ATEX builds only)			
Transformer	Value	Manufacturer	Part number
All	100 mA Quick blow	Bussmann	S500
		Littlefuse	217

## 14. Vibration, Shock and Noise

Standard IQT range actuators are suitable for applications where vibration and shock severity does not exceed the following:

Type	Level
Plant induced vibration	1g rms total for all vibration within the frequency range of 10 to 1000 Hz
Shock	5g peak acceleration
Seismic	2g acceleration over a frequency range of 1 to 50 Hz if it is to operate during and after the event
Emitted noise	Tests have shown that at 1m generated noise does not exceed 65 db(A)

## 15. Conditions of Safe Use

### 15.1 Thread details for ATEX, IECEx and UKEX approved actuators

Threaded Flamepath	Thread Size	Thread Length	Actuator Type and Size
9V Battery Cover	M40x1.5	10.00	All Types and Sizes
Cable Entry	M25x1.5	20.00	All Types and Sizes
	M40x1.5	20.00	All Types and Sizes

### 15.2 Maximum constructional flamepath gaps for ATEX, IECEx and UKEX approved actuators

Flamepath	Max. Gap (mm)	Min. Length (mm)	Actuator
Motor Cover / Gearcase	0.15	26.00	IQT all sizes
Motor-shaft shroud / Gearcase	-0.05 / 0.00	26.00	IQT all sizes
Motor-shaft / Shroud	0.24	25.00	IQT all sizes
Terminal Bung / Gearcase (IIB)	0.20	27.00	IQT all sizes
Terminal Bung / Gearcase (IIC, FM & CSA Group B)	0.115	27.00	IQT all sizes
Terminal Cover / Gearcase	0.15	27.00	IQT all sizes
Electrical Cover / Gearcase	0.15	26.00	IQT all sizes
Encoder shaft / Encoder shaft bush	0.08	27.00	IQT all sizes
Encoder shaft bush / Gearcase	0.07	25.00	IQT all sizes

**Note:** Negative sign denotes an interference fit.

When the equipment is marked with a T6 temperature classification/ T80°C maximum surface temperature, the following duty cycle is applicable:

#### **IQT50, IQT100, IQT125, IQT250, IQT500, IQT1000 and IQT2000**

Nominal 60 starts at a rate of not exceeding 600 starts per hour, 15 minutes rated based upon a nominal 75% of rated torque.

#### **IQT3000**

Nominal 60 starts at a rate of not exceeding 600 starts per hour, 15 minutes rated based upon a nominal 50% of rated torque.

#### **EMC**

The equipment is intended for use in an industrial electromagnetic environment.

## 16. IQT Shutdown Battery Operating Conditions

**The Shutdown Battery option comprises a Lithium Ion battery installed within the actuator enclosure. Shutdown Battery instructions do not apply to the Lead Acid Battery Backup option that is housed within the terminal enclosure. Refer to PUB002-105 for information on the Lead Acid Battery Backup option.**

IQT Shutdown Battery actuators must be stored in a dry place and sufficiently protected from the outside environment. Storage temperature must remain within -20 to +50 °C (-4 to +122 °F).

**Before storing an IQT Shutdown Battery actuator, apply mains power and allow the actuator to fully charge the battery pack. Charging must be performed in an ambient temperature of 0 to +40 °C (+32 to +104 °F). Failure to fully charge the battery may result in premature aging and degradation of battery performance.**

For the -20 °C build, charging can only take place if the ambient temperature is -10 °C or above.

Rotork recommend recharging the battery to full every 3 years to prevent excessive degradation of battery performance. More frequent charging will not damage the battery.

Duty ratings for IQT range actuators including Shutdown Battery option are detailed right. These apply at all times during operation.

The configured Shutdown Action is unavailable for 20 seconds immediately after power is restored. Normal electrical operation of the actuator is available at all times while mains power is present.

Size	Number of 90° Operations	Recharge Time for one 90° Operation (minutes)
IQT50	80	2
IQT100	72	2
IQT125	30	5
IQT250	14	11
IQT500	8	19
IQT1000	4	38
IQT2000	2	75

### Isolating IQT:

Power supply: 24 VDC, < 600 VAC  
50/60 Hz.

Nominal 60 starts per hour at a rate not exceeding 600 starts per hour.

15 minutes rated based on a nominal torque of 75% rated torque for temperature range -50 to +60 °C (-58 to +140 °F).

6 minutes rated based on a nominal torque of 75% rated torque for temperature range +60 to +70 °C (+140 to +158 °F).

### Modulating IQTM and IQTF:

Power supply: 24 VDC, < 600 VAC  
50/60 Hz.

Nominal 1,800 starts per hour.

50% duty cycle based on modulating torque of 50% rated torque for temperature range -50 to +60 °C (-58 to +140 °F).

20% duty cycle based on modulating torque of 50% rated torque for temperature range +60 to +70 °C (+140 to +158 °F).

## 16.1 Shutdown Battery Commissioning

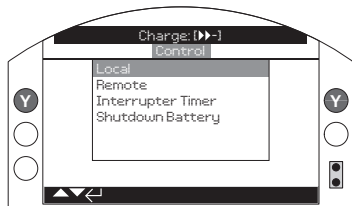

Fig. 16.1.1

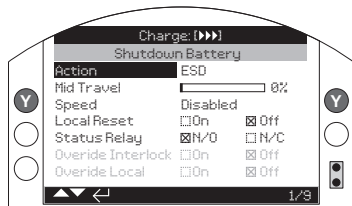

Fig. 16.1.2

### 1 / 9 Action

The shutdown battery can be configured for one of the following actions. The actuator will power off after the shutdown action is complete (excludes UPS mode).

**UPS mode** – actuator will continue to respond to control commands until battery capacity is depleted.

**ESD** – actuator will perform the configured ESD action. Refer to PUB002-040 for details.

**Open** – actuator will open on loss of mains power.

**Mid Position** – actuator will travel to the preconfigured intermediate position (2/9).

**Close** – actuator will close on loss of mains power.

**Stayput** – actuator will stop and stay in position. Any control commands will be ignored.

Press to select Action function. Use or to select required setting. Press to set.

### 2 / 9 Mid Travel

Set the stop position for the Mid Position shutdown action. Only applicable for Mid Position shutdown action (1/9).

**0 - 100%** – configurable for any position at 1% increments.

Press to select Mid Travel function. Use or to adjust desired position. Press to set.

### 3 / 9 Speed

Set the operating speed for the shutdown action. Only applicable to ESD, Open, Mid Position or Close shutdown action.

**Disabled** – shutdown action will perform at the normal actuator operating speed. Refer to Section 8.6.

**25 - 100%** – shutdown action will operate at the configured speed. Configurable at 1% increments. 100% is the actuator rated speed.

Press to select Speed function. Use or to adjust desired speed. Press to set.

### 4 / 9 Local Reset

The local reset requires an operator to interact with the actuator local controls after a power loss event.

**On** – actuator will not be operational until the local control knob is moved to STOP after a power loss.

**Off** – actuator will be fully operational after a power loss.

Press to select Local Reset function. Use or to check the required setting. Press to set.

### 5 / 9 Status Relay

Set the contact form for the status relay. The relay indicates remaining battery charge status.

**N/O** – Normally Open contact form. Relay will make if charge is high enough for one full stroke.

**N/C** – Normally Closed contact form. Relay will break if charge is high enough for one full stroke.





Press to select Status Relay function. Use or to check the required setting. Press to set.

## 6 / 9 Override Interlock

The shutdown action will only perform if certain interlock conditions are met. Override interlock allows the shutdown action to perform when an interlock signal is active.

**On** – the shutdown action will perform regardless of interlock status.

**Off** – the shutdown action will not perform if an interlock is inhibiting operation.



Press  to select Override Interlock function. Use  or  to check the required setting. Press  to set.

## 7 / 9 Override Local

The shutdown action will only perform if the actuator is in a suitable operating mode. Override local allows the shutdown action to perform in LOCAL.

**On** – the shutdown action will perform in REMOTE and LOCAL.

**Off** – the shutdown action will only perform in REMOTE.



Press  to select Override Local function. Use  or  to check the required setting. Press  to set.

## 8 / 9 Override Timer

The shutdown action will operate subject to the interrupter timer operating characteristics.

**On** – the shutdown action will ignore the interrupter timer settings.

**Off** – the shutdown action will conform to the interrupter timer settings.



Press  to select Override Timer function. Use  or  to check the required setting. Press  to set.

## 9 / 9 150% Torque

Set the torque protection level during the shutdown action. Only applicable to ESD, Open, Mid Position or Close shutdown action.

**On** – the shutdown action will perform with up to 150% torque.

**Off** – the shutdown action will perform with the set torque limit. Refer to Sections 8.5 and 8.6.

Press  to select 150% Torque function. Use  or  to check the required setting. Press  to set.

**⚠ WARNING: ESD shutdown action may override STOP if configured to override stop in the ESD setting menu. Always apply caution when working on or near IQT actuators with the Shutdown Battery option.**

# rotork®



PUB002-065-00

---

*UK*

Rotork plc

*tel* +44 (0)1225 733200

*email* mail@rotork.com

*USA*

Rotork Controls Inc.

*tel* +1 (585) 247 2304

*email* info@rotork.com

A full listing of our worldwide sales and service network is available on our website.

**[www.rotork.com](http://www.rotork.com)**

---

**Original instructions: English language version only.** As part of a process of on-going product development, Rotork reserves the right to amend and change specifications without prior notice. Published data may be subject to change. For the very latest version release, visit our website at [www.rotork.com](http://www.rotork.com)

The name Rotork is a registered trademark. Rotork recognises all registered trademarks. The Bluetooth® word mark and logos are registered trademarks owned by Bluetooth SIG, Inc. and any use of such marks by Rotork is under license. Published and produced in the UK by Rotork. POLJB0724

**PUB002-065-00**  
**Date of issue 08/24**

---